

BOET



Catálogo
Catalogue

BOET

Grifería noble
desde 1928



Boet, grifería noble desde 1928.

Noble tapware since 1928.

Robinetterie noble depuis 1928.

Con casi un siglo de trayectoria, **BOET** sigue evolucionando para ofrecer las mejores soluciones en grifería. Cada pieza refleja el equilibrio entre innovación, calidad y compromiso con el medio ambiente.

With nearly a century, BOET continues to evolve to offer the best faucet solutions. Each piece reflects a balance between innovation, quality, and commitment to the environment.

Avec près d'un siècle d'expérience, BOET continue d'évoluer pour offrir les meilleures solutions de robinetterie. Chaque pièce reflète un équilibre entre innovation, qualité et engagement environnemental.

Excelencia en la fabricación

En BOET fabricamos cada grifo como si fuera único. Nuestros procesos aseguran precisión, coherencia y calidad en cada pieza.

At BOET, we manufacture each faucet as if it were unique. Our processes ensure precision, consistency, and quality in every piece.

Chez BOET, nous fabriquons chaque robinet comme s'il était unique. Nos processus garantissent précision, constance et qualité pour chaque pièce.



Tecnología y diseño sostenible

Desde 2015 integramos materiales reciclables y procesos ecoeficientes. Incorporamos tecnologías que reducen agua y energía, minimizando el impacto ambiental.

Since 2015, we have been integrating recyclable materials and eco-efficient processes. We incorporate technologies that reduce water and energy consumption, minimizing environmental impact.

Depuis 2015, nous intégrons des matériaux recyclables et des procédés éco-efficaces. Nous développons des technologies qui réduisent la consommation d'eau et d'énergie, minimisant ainsi l'impact environnemental.



Innovación

La innovación guía nuestro trabajo. Desarrollamos sistemas que optimizan el consumo de agua y soluciones ergonómicas que anticipan las necesidades de hogares y espacios colectivos.

Innovation guides our work. We develop systems that optimize flow and ergonomic solutions that anticipate the needs of homes and public spaces.

L'innovation guide notre travail. Nous développons des systèmes qui optimisent le flux et des solutions ergonomiques qui anticipent les besoins des maisons et des espaces publics.



Feliu Boet, historia.

Feliu Boet, history.

Feliu Boet, histoire.



En 1928, en la efervescente Barcelona de principios de siglo, **Feliu Boet Comas** y **Salvador Teis** emprendieron un sueño: crear griferías de precisión, belleza y durabilidad.

In 1928, in the vibrant Barcelona of the early 20th century, Feliu Boet Comas and Salvador Teis embarked on a dream: to create faucets defined by precision, beauty, and durability.

En 1928, dans la Barcelone bouillonnante du début du siècle, Feliu Boet Comas et Salvador Teis se lancèrent dans un rêve : créer des robinetteries alliant précision, beauté et durabilité.

Solo un año después, Boet publicaba su **primer catálogo**, un testimonio de ingenio y modernidad.

Only a year later, Boet published its first catalogue, a testament to ingenuity and modernity.

Un an seulement plus tard, Boet publia son premier catalogue, un témoignage d'ingéniosité et de modernité.



En **1939**, tras años de esfuerzo y crecimiento, la empresa desarrolló su **primera generación de galvanizados**, un hito técnico que revolucionó el acabado y la protección de las piezas metálicas.

In 1939, after years of effort and growth, the company developed its first generation of galvanised finishes – a technical milestone that revolutionised the protection and appearance of metal components.

En 1939, après des années d'efforts et de croissance, l'entreprise développa sa première génération de galvanisations, un jalon technique qui révolutionna la protection et la finition des pièces métalliques.

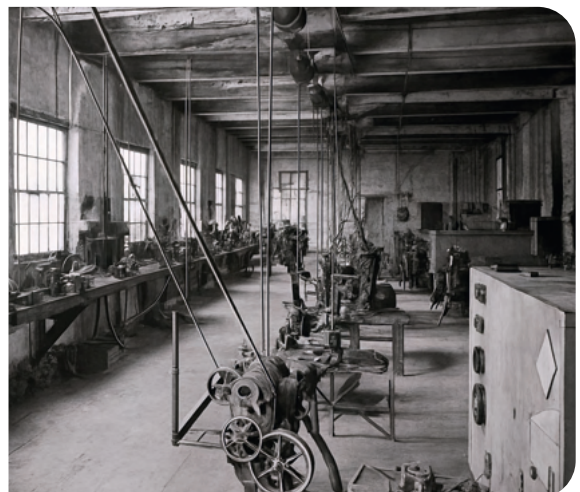
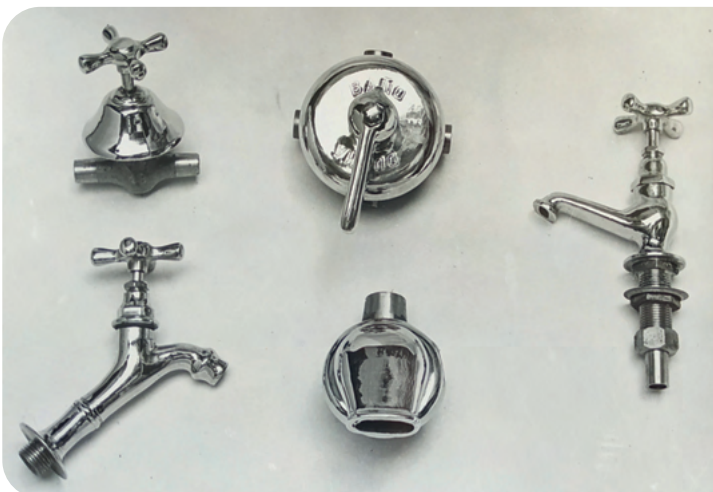



Los **años 60** trajeron un nuevo impulso. España vivía el auge del consumo y la modernidad se colaba en los hogares. Boet evolucionó su marca, introduciendo diseños rompedores.

The 1960s brought renewed momentum. Spain was experiencing a rise in consumption, and modernity was entering households. Boet evolved its brand, introducing groundbreaking designs.

Les années 60 apportèrent un nouvel élan. L'Espagne vivait l'essor de la consommation et la modernité s'invitait dans les foyers. Boet fit évoluer sa marque en introduisant des designs audacieux.

En **1974**, la inauguración de la nueva **planta de producción en Cervelló (Barcelona)** consolidó la expansión. Cuatro años más tarde, la firma celebraba su **50 aniversario** con fábricas en Cervelló y Calatayud.

In 1974, the inauguration of a new production plant in Cervelló (Barcelona) consolidated the company's expansion. Four years later, the brand celebrated its 50th anniversary with factories in Cervelló and Calatayud.

En 1974, l'inauguration de la nouvelle usine de production à Cervelló (Barcelone) consolida l'expansion de l'entreprise. Quatre ans plus tard, la marque célèbre son 50e anniversaire avec des usines à Cervelló et Calatayud.



El crecimiento continuó en **1991** con la ampliación y modernización de Cervelló, que integró todos los procesos productivos bajo un mismo techo.

Growth continued in 1991 with the expansion and modernisation of Cervelló, integrating all production processes under one roof.

La croissance se poursuit en 1991 avec l'agrandissement et la modernisation de Cervelló, intégrant tous les processus de production sous un même toit.

Con visión global, en **2002** la empresa emprendió una **inversión estratégica en China**, creando una planta de producción integral y un equipo comercial dedicado al mercado asiático.

With a global vision, in 2002 the company undertook a strategic investment in China, establishing a fully integrated production plant and a commercial team dedicated to the Asian market.

Avec une vision globale, en 2002 l'entreprise réalisa un investissement stratégique en Chine, créant une usine de production intégrée et une équipe commerciale dédiée au marché asiatique.





El compromiso con el planeta se reforzó en **2015**, cuando Boet incorporó **criterios de sostenibilidad** en toda su estrategia, apostando por materiales reciclables y tecnologías de ahorro de agua y energía.

Its commitment to the planet strengthened in 2015, when Boet incorporated sustainability criteria across its strategy, promoting recyclable materials and water- and energy-saving technologies.

L'engagement envers la planète se renforce en 2015, lorsque Boet intègre des critères de durabilité dans toute sa stratégie, misant sur des matériaux recyclables et des technologies d'économie d'eau et d'énergie.



En **2023**, la compañía presentó una nueva generación de **acabados PVD**, con nuevas texturas y colores que ampliaron las posibilidades estéticas.

In 2023, the company presented a new generation of PVD finishes, with textures and colours.

En 2023, la société présente une nouvelle génération de finitions PVD, avec des textures et des couleurs.



Y en **2025**, Boet abre una nueva etapa con la inauguración de su **planta en Sant Esteve Sesrovires**.

And in 2025, Boet opens a new chapter with the inauguration of its plant in Sant Esteve Sesrovires.

Et en 2025, Boet ouvre une nouvelle étape avec l'inauguration de son usine de Sant Esteve Sesrovires.

Casi un siglo después, Boet sigue fiel a su esencia: **fabricar cada grifo como si fuera único**. Una historia de constancia, innovación y respeto por el agua que ha convertido su nombre en sinónimo de fiabilidad y diseño.

Almost a century later, Boet remains true to its essence: crafting every faucet as if it were unique. A story of perseverance, innovation and respect for water that has turned its name into a symbol of reliability and design.

Près d'un siècle plus tard, Boet reste fidèle à son essence : fabriquer chaque robinet comme s'il était unique. Une histoire de constance, d'innovation et de respect pour l'eau qui a fait de son nom un synonyme de fiabilité et de design.

Proceso productivo integral.

Integrated production process.

Processus de production intégré.

En Boet controlamos todas las fases del proceso productivo, lo que nos permite adaptarnos a cada proyecto con precisión.

At Boet, we control every stage of the production process, allowing us to adapt with precision to each project.

Chez Boet, nous maîtrisons toutes les étapes du processus de production, ce qui nous permet de nous adapter avec précision à chaque projet.



1 DISEÑO



2 INGENIERÍA



3 LABORATORIO



4 FUNDICIÓN



5 MECANIZADO



6 PULIDO

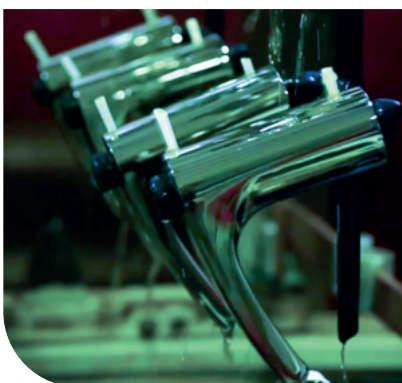

7 ACABADO



8 MONTAJE



9 EXPEDICIÓN

Atelier Boet.



El proceso creativo en el **Atelier Boet** es un viaje apasionante que transforma ideas en auténticas obras maestras. Nuestro **equipo creativo**, día tras día convierte sus conceptos en realidades, desde los primeros bocetos a mano que nacen de la **intuición** y de la vasta **experiencia en el sector**.

En esta travesía, **la creatividad se fusiona con tecnología punta** para el desarrollo de piezas industriales. Este matrimonio busca lograr unificar en una sola pieza la estética sublime y **el gesto artístico con la eficiencia funcional, la sostenibilidad y la eficiencia energética**, pensando en las necesidades del usuario y apostando por los mejores materiales disponibles en el mercado.



The creative process at Atelier Boet is an exciting journey that transforms ideas into authentic masterpieces. Our creative team, day after day, turns their concepts into realities, starting from the initial hand sketches born from intuition and extensive experience in the industry.

In this journey, creativity merges with cutting-edge technology for the development of industrial pieces. This synergy aims to unify in a single piece sublime aesthetics and artistic gesture with functional efficiency, sustainability, and energy efficiency, considering user needs and opting for the best materials available in the market.

Le processus créatif à l'Atelier Boet est un voyage passionnant qui transforme les idées en de véritables chefs-d'œuvre. Notre équipe créative, jour après jour, concrétise ses concepts, depuis les premières esquisses à la main nées de l'intuition et de l'expérience approfondie dans le secteur.

Dans cette aventure, la créativité se fusionne avec la technologie de pointe pour le développement de pièces industrielles. Cette synergie vise à unifier en une seule pièce l'esthétique sublime et le geste artistique avec l'efficacité fonctionnelle, la durabilité et l'efficacité énergétique, en tenant compte des besoins de l'utilisateur et en optant pour les meilleurs matériaux disponibles sur le marché.

Calidad y certificaciones.

Quality and certificates.

Qualité et certificats.

Los procesos de fabricación y control de calidad de Boet, son auditados por entes oficiales de diferentes países.

Boet's manufacturing and quality control processes are audited by official entities from different countries.

Les processus de fabrication et de contrôle qualité de Boet sont audités par des entités officielles de différents pays.



Certificados

Los productos de FELIU BOET, están fabricados de acuerdo a los estándares europeos de calidad (Norm UNE-EN 19703, UNE-EN-817, UNE-EN-111...), ofreciendo al usuario un producto con la seguridad, fiabilidad y durabilidad esperadas.

Desde la materia prima, hasta el producto final, son sometidos a un estricto control de calidad incluyendo pruebas como:

- Ensayo estanqueidad.
- Ensayo de accionamiento y controles.
- Ensayo de fatiga.
- Ensayos hidráulicos.

Certificates

FELIU BOET products are manufactured according to European quality standards (Norm UNE-EN 19703, UNE-EN-817, UNE-EN-111...), offering the user a product with the safety, reliability and durability expected.

From the raw material, to the final product, they are subjected to a strict quality control including tests such as:

- *Sealing test.*
- *Test drive and controls.*
- *Fatigue test.*
- *Hydraulic tests.*

Certificats

Les produits FELIU BOET sont fabriqués selon les normes de qualité européennes (Norme UNE-EN 19703, UNE-EN-817, UNE-EN-111...), offrant à l'utilisateur un produit avec la sécurité, la fiabilité et la durabilité attendues.

De la matière première au produit final, ils sont soumis à un contrôle de qualité strict incluant des tests tels que:

- *Test d'étanchéité.*
- *Test de fonctionnement et de contrôles.*
- *Essai de fatigue.*
- *Essais hydrauliques.*



Boet, tecnología que cuida el agua.

Technology that saves water.

Une technologie qui préserve l'eau.



En Boet entendemos el agua como un recurso esencial que debe emplearse con respeto y responsabilidad. Por ello, fruto de una innovación constante y de casi un siglo de experiencia, desarrollamos tecnologías que optimizan el consumo y reducen la demanda energética.

At Boet, we consider water a vital resource that must be used with respect and responsibility. Driven by continuous innovation and nearly a century of expertise, we develop technologies that optimize water consumption and reduce energy demand.

Chez Boet, l'eau est un bien essentiel que nous devons utiliser avec respect et responsabilité. Grâce à une innovation continue et à près d'un siècle d'expérience, nous développons des technologies qui optimisent la consommation d'eau et réduisent la demande énergétique.

Sistemas de ahorro **Boet.**

*Saving technologies.
Technologies d'économie.*



Sistema Boet Double-Clic® – Control natural del caudal

Un sistema inteligente con dos posiciones de apertura en la maneta. En la posición intermedia, el grifo limita automáticamente el caudal, permitiendo ahorrar hasta un 50% de agua.

Boet Double-Clic® System – Natural flow control

An intuitive dual-position handle mechanism. In the intermediate position, the faucet reduces flow automatically, saving up to 50% of water.

Système Boet Double-Clic® – Contrôle intuitif du débit

Un mécanisme intelligent à deux positions dans la manette. En position intermédiaire, le robinet limite automatiquement le débit, permettant d'économiser jusqu'à 50 % d'eau.

Sistema Boet Cold-Open® – Apertura del grifo en agua fría para una mayor eficiencia energética

La maneta abre siempre en agua fría en su posición central. Así evitamos el encendido involuntario del calentador o caldera en acciones diarias, reduciendo de forma inmediata el consumo energético.

Boet Cold-Open® System – Cold start for energy efficiency

The handle opens in cold water in its central position. This prevents unnecessary activation of the boiler during simple tasks, reducing energy consumption instantly.

Système Boet Cold-Open® – Ouverture à froid pour une efficacité énergétique accrue.

La manette s'ouvre toujours sur l'eau froide en position centrale. Cela évite l'activation involontaire du chauffe-eau dans les gestes quotidiens, réduisant ainsi immédiatement la consommation d'énergie.

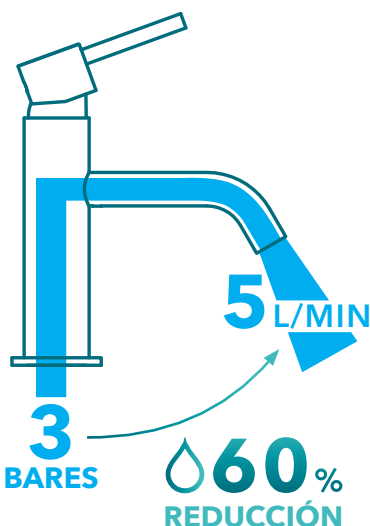
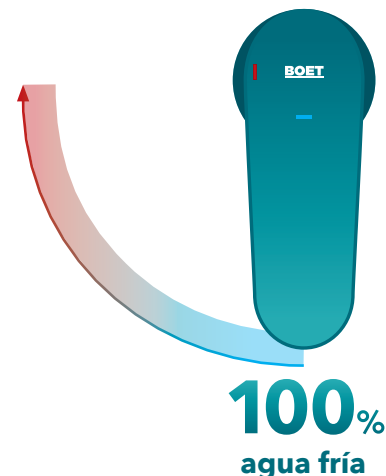

Diseños de caudal limitado – Máxima eficiencia con pleno confort

Boet diseña griferías que optimizan el flujo manteniendo una experiencia cómoda y equilibrada. En nuestras series ecológicas, los grifos de lavabo consumen menos de 5 l/min a 3 bar.

Limited-Flow Designs – Maximum efficiency, full comfort

Boet develops faucets engineered to optimize water output without compromising comfort. In our eco-flow series, basin faucets achieve consumption levels under 5 l/min at 3 bar.

Designs à débit limité – Efficacité maximale, confort total

Boet conçoit des robinets qui optimisent le flux tout en préservant une expérience agréable. Dans nos séries écologiques, les mitigeurs de lavabo consomment moins de 5 l/min à 3 bar.

Boet, cerca de ti en todo momento.

Always by your side.

Toujours à vos côtés.

En Boet creemos en la importancia de estar a tu lado en cada paso. Por eso, nuestro equipo de Atención al Cliente te acompaña siempre con una voz amable, dispuesta a resolver cualquier consulta de forma rápida y eficaz.

At Boet, we believe in being there for you every step of the way. Our Customer Service team is always ready with a friendly voice to assist you quickly and efficiently with any inquiry.

Chez Boet, nous croyons en l'importance de vous accompagner à chaque étape. Notre service client est toujours prêt à vous répondre avec bienveillance, de manière rapide et efficace.



¿En qué podemos ayudarte?

How can we help you?

Comment pouvons-nous vous aider?



Consultas sobre nuestros productos.
*Product information.
Information sur nos produits.*



Pedidos.
*Orders.
Commandes.*



Facturación.
*Billing.
Facturation.*



Recambios.
*Spare parts.
Pièces de rechange.*



Información técnica.
*Technical support.
Support technique.*



Red comercial.
*Sales network.
Réseau commercial.*

- **Teléfono** | *Phone* | *Téléphone* : +34 93 684 05 04
- **Área comercial** | *Sales Department* | *Service commercial* : comercial@feliuboet.com
- **Administración** | *Administration* | *Administration* : admon@feliuboet.com
- **Soporte técnico** | *Technical Support* | *Support technique* : calidad@feliuboet.com

Desde nuestra página web

From our website

Depuis notre site web

Toda la información que necesitas, a un solo clic. En nuestra web podrás:

All the information you need, just one click away. On our website you can:

Toutes les informations dont vous avez besoin, à portée de clic. Sur notre site, vous pouvez:

- Consultar todos nuestros productos.

Browse our complete range of products.

Consulter l'ensemble de nos produits.

- Enviar consultas directamente a nuestro equipo a través del formulario online.

Submit inquiries directly to our team through our online form.

Envoyer vos demandes directement via notre formulaire en ligne.

- Descargar documentación.

Download documentation.

Télécharger la documentation.

- Acceder a la información técnica detallada.

Access detailed technical information.

Accéder aux fiches techniques détaillées.

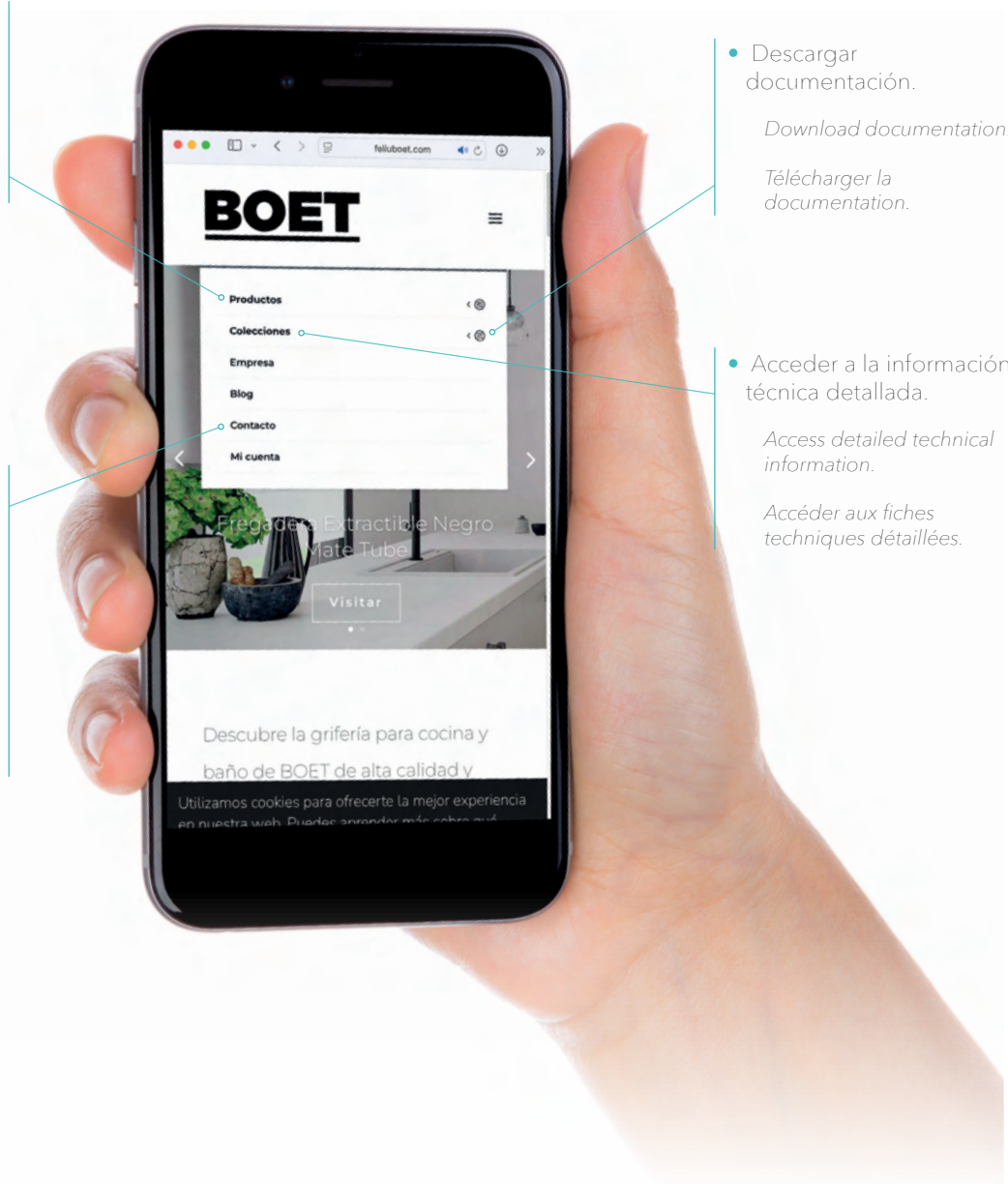

Un espacio pensado para acompañarte en cada proyecto, fácil, intuitivo y siempre actualizado.

A digital space designed to support every project: simple, intuitive and always up to date.

Un espace numérique conçu pour vous accompagner dans chaque projet : simple, intuitif et toujours à jour.

Novedades BOET



Presentamos las últimas incorporaciones pensadas y desarrolladas en el **Atelier Boet** por nuestro equipo de técnicos y creativos.

We present the latest additions conceived and developed in the Boet Atelier by our team of technicians and designers.

Nous présentons les dernières créations conçues et développées dans l'Atelier Boet par notre équipe de techniciens et de créatifs.



Nuevo acabado en cobre cepillado PVD.

Descubre la sofisticada artesanía de nuestro último acabado en PVD, meticulosamente elaborado para ofrecer belleza y durabilidad, garantizando que tu espacio sea un testimonio de elegancia. Nuestro índice de acabados completo está disponible en la página 24.

New brushed copper PVD finish. Discover the sophisticated craftsmanship of our latest PVD finish, meticulously crafted for beauty and durability, ensuring your space is a testament to elegance. Our full finishes index is available on page 24.

Nouvelle finition cuivre brossé PVD. Découvrez la sophistication de notre dernière finition PVD, soigneusement conçue pour allier beauté et durabilité dans votre espace empreint d'élégance. Notre index complet des finitions est disponible à la page 24.



Nuevas colecciones.

Aston y Duna son las nuevas colecciones nacidas en nuestro Atelier para expresar elegancia, equilibrio y funcionalidad.

New collections.

Aston and Duna are the new collections born in our Atelier to express elegance, balance, and functionality.

Nouvelles collections.

Aston et Duna sont les nouvelles collections nées dans notre Atelier pour exprimer l'élégance, l'équilibre et la fonctionnalité.

ASTON

▲ P - 80



DUNA

▲ P - 86



Nuevas griferías de cocina preparadas para osmosis y filtros de carbón.

Incorporamos Udine y Doha, dos nuevos modelos de grifería de cocina con diseños irrepetibles y con altas prestaciones.

New kitchen taps prepared for osmosis and carbon filters.

We introduce Udine and Doha, two new kitchen tap models featuring unique designs, and high performance.

Nouveaux mitigeurs de cuisine compatibles avec l'osmose et les filtres à charbon.

Nous présentons Udine et Doha, deux nouveaux modèles de robinetterie de cuisine au design unique et aux hautes performances.



UDINE

▼ P - 132

DOHA

▲ P - 132



Nuevas columnas de ducha.

Con acabados en cromo y negro mate, nacen estas dos nuevas columnas de ducha: Sena, elegante y sensual columna monomando con rociador. Termoplus, una excelente columna termostática con altas prestaciones.

New shower columns.

With chrome and matte black finishes, two new shower columns are born: Sena, an elegant and sensual single-lever column with overhead shower; and Termoplus, an outstanding thermostatic column offering high performance.

Nouvelles colonnes de douche.

Avec des finitions chromées et noires mates, deux nouvelles colonnes de douche voient le jour : Sena, une élégante et sensuelle colonne monocommande avec pomme de douche, et Termoplus, une excellente colonne thermostatique aux hautes performances.



SENA

▲ P - 148



TERMOPLUS

▲ P - 152

FB-BOX: Simplifica tu vida.

Simplify Your Life.

Simplifiez-vous la vie.

La tecnología **FB-BOX** de Boet nace para facilitar el trabajo del instalador y ofrecer una experiencia impecable al usuario final. Un sistema que combina **precisión, adaptabilidad y mantenimiento sencillo**, garantizando una instalación perfecta y un funcionamiento fiable durante años.

Boet's FB-BOX technology is designed to make installers' work easier while offering an impeccable experience for the end user. A system that combines precision, adaptability and easy maintenance, ensuring a perfect installation and reliable performance for years to come.

La technologie FB-BOX de Boet est conçue pour faciliter le travail de l'installateur et offrir une expérience irréprochable à l'utilisateur final. Un système qui combine précision, adaptabilité et entretien facile, garantissant une installation parfaite et un fonctionnement fiable pendant des années.

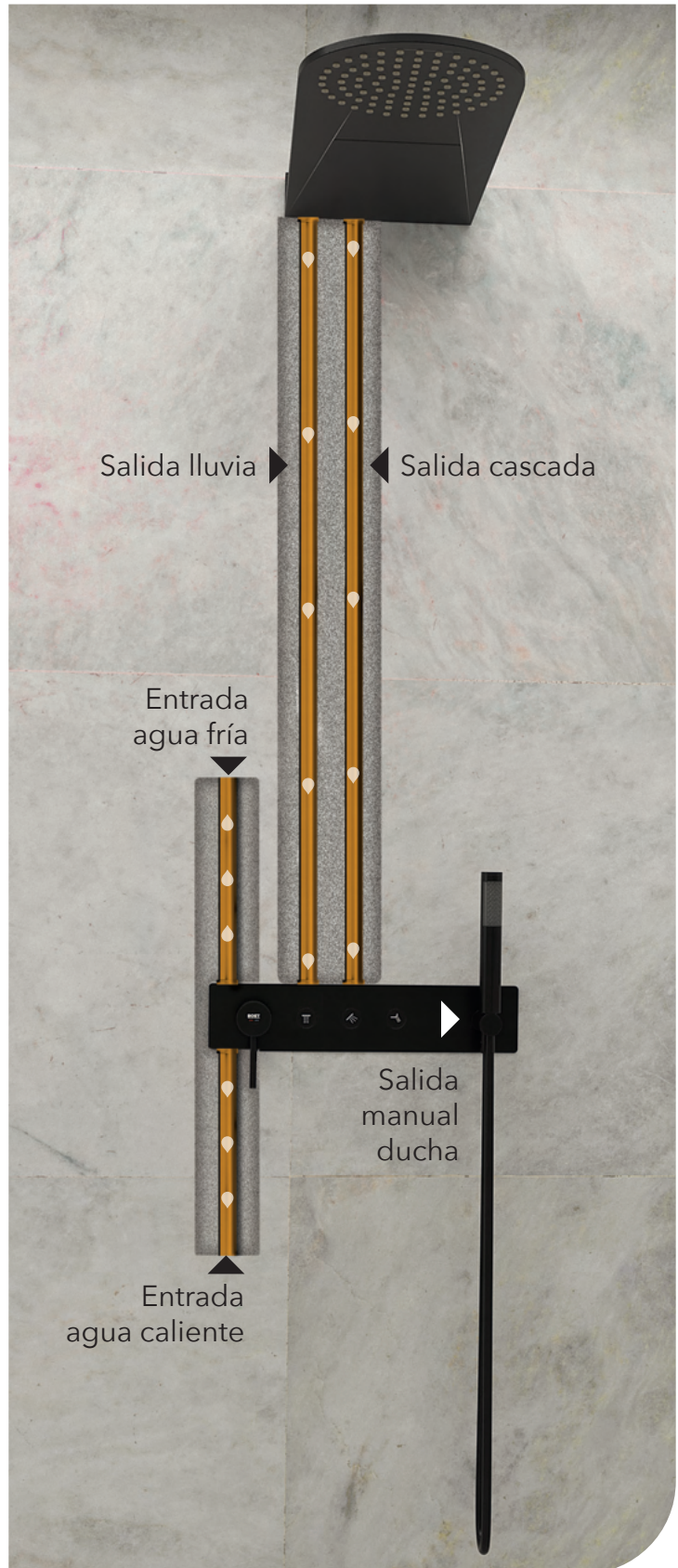

Descubre nuestra gama de **FB-BOX**.

Discover our full FB-BOX range.

Découvrez toute notre gamme FB-BOX.

Precisión absoluta.

El nivel de burbuja integrado permite una alineación perfecta en todo momento, asegurando un montaje impecable.

Absolute precision.

The built-in spirit level ensures perfect alignment at all times, guaranteeing a flawless installation.

Précision absolue.

Le niveau à bulle intégré assure un alignement parfait à tout moment, garantissant une installation impeccable.

Encaje perfecto.

FB-BOX ofrece múltiples puntos de fijación, accesibles tanto frontal como posteriormente, para adaptarse a diferentes escenarios de instalación.

Perfect fit.

FB-BOX provides multiple fixing points, accessible from the front or the back, adapting to different installation scenarios.

Ajustement parfait.

FB-BOX offre plusieurs points de fixation, accessibles par l'avant ou par l'arrière, pour s'adapter à différents scénarios d'installation.

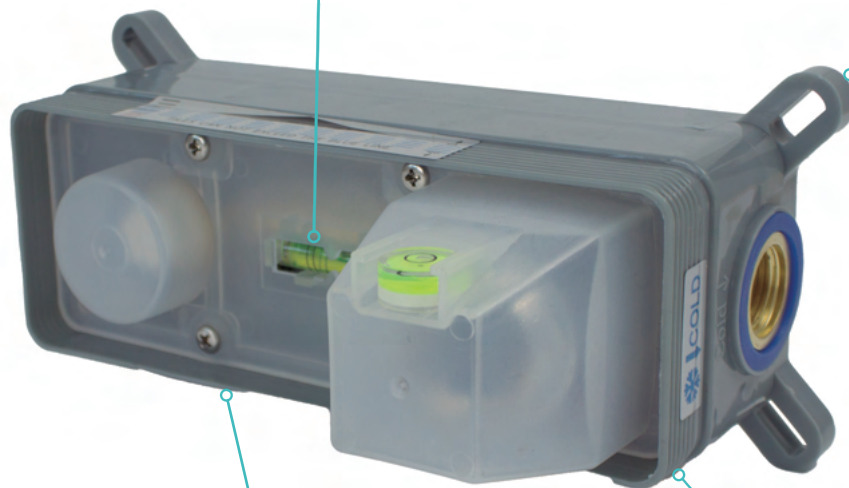

Accesibilidad y mantenimiento.

Diseñada para ser completamente accesible, FB-BOX permite un mantenimiento cómodo y rápido, garantizando máxima fiabilidad a largo plazo.

Accessibility and maintenance.

Designed to be fully accessible, FB-BOX allows comfortable and quick maintenance, ensuring maximum long-term reliability.

Accessibilité et maintenance.

Conçue pour être entièrement accessible, FB-BOX permet un entretien pratique et rapide, garantissant une fiabilité maximale à long terme.

Adaptabilidad total.

Su práctico indicador de profundidad facilita una medición rápida y precisa, permitiendo ajustar el cuerpo empotrado a la profundidad exacta del boquete en pared.

Total adaptability.

Its practical depth indicator allows quick and accurate measurement, enabling the recessed body to be adjusted to the exact depth of the wall cavity.

Adaptabilité totale.

Son indicateur de profondeur pratique permet une mesure rapide et précise, afin d'ajuster le corps encastré à la profondeur exacte de la cavité murale.



FB-BOX 556

Apta sólo para las referencias en color que acaban en 556.

Suitable only for colour references ending in 556.

Uniquement compatible avec les références en finition couleur se terminant par 556.



Vídeo de instalación
Installation video
Vidéo d'installation



FB-BOX 112

Apta para lavabos empotrados cuya referencia acaba en 112.

Suitable for concealed basin mixers with reference numbers ending in 112.

Compatible avec les mitigeurs de lavabo encastrés dont la référence se termine par 112.



Vídeo de instalación
Installation video
Vidéo d'installation



FB-BOX 149

Apta para duchas empotradas con botones push, acabadas en 148 y 149.

Suitable for concealed shower systems with push buttons, corresponding to references ending in 148 and 149.

Compatible avec les systèmes de douche encastrés avec boutons push, correspondants aux références se terminant par 148 et 149.

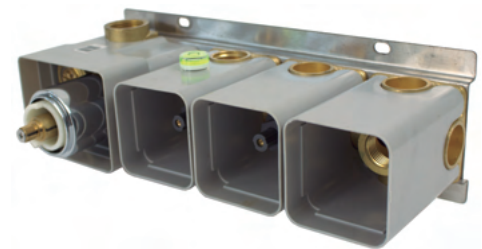

Vídeo de instalación
Installation video
Vidéo d'installation



Boet Sustainable Construction.

Boet Sustainable Construction (BSC) representa el firme compromiso de Boet con la construcción sostenible y la eficiencia hídrica en el ámbito residencial, hotelero y contract.

Boet Sustainable Construction (BSC) represents Boet's strong commitment to sustainable construction and water efficiency across the residential, hospitality and contract sectors.

Boet Sustainable Construction (BSC) représente l'engagement ferme de Boet en faveur de la construction durable et de l'efficacité hydrique dans les secteurs résidentiel, hôtelier et contract.

A través del programa BSC, Boet desarrolla colecciones de grifería con niveles de caudal diseñados para cumplir con los requisitos de certificaciones internacionales como BREEAM, LEED y EDGE. Soluciones que permiten a arquitectos, promotores e interioristas integrar productos de alta calidad estética y técnica en proyectos que priorizan la sostenibilidad y el ahorro de recursos.

Además, gracias a nuestra capacidad industrial y conocimiento técnico, en Boet podemos adaptar distintos modelos a caudales inferiores, ajustándonos a las necesidades específicas de cada proyecto y a los estándares exigidos por cada certificación.

El resultado es una grifería que mantiene intactos el diseño, la fiabilidad y la experiencia de uso, reduciendo al mismo tiempo el consumo de agua y contribuyendo a edificios más responsables y eficientes.

Through the BSC programme, Boet develops tapware collections with optimised flow rates, designed to meet the requirements of international certifications such as BREEAM, LEED and EDGE. These solutions enable architects, developers and interior designers to integrate products with high aesthetic and technical value into projects that prioritise sustainability and resource efficiency.

In addition, thanks to our industrial capacity and in-depth technical expertise, Boet can adapt different models to lower flow rates, adjusting to the specific needs of each project and to the standards required by each certification.

The result is tapware that fully preserves design, reliability and user experience, while reducing water consumption and contributing to more responsible and efficient buildings.

À travers le programme BSC, Boet développe des collections de robinetterie avec des débits optimisés, conçus pour répondre aux exigences de certifications internationales telles que BREEAM, LEED et EDGE. Des solutions qui permettent aux architectes, promoteurs et architectes d'intérieur d'intégrer des produits à haute valeur esthétique et technique dans des projets privilégiant la durabilité et l'économie des ressources.

De plus, grâce à notre capacité industrielle et à notre expertise technique approfondie, Boet peut adapter différents modèles à des débits réduits, en s'ajustant aux besoins spécifiques de chaque projet et aux standards exigés par chaque certification.

Le résultat est une robinetterie qui préserve pleinement le design, la fiabilité et l'expérience d'utilisation, tout en réduisant la consommation d'eau et en contribuant à des bâtiments plus responsables et plus efficaces.



Producto que cumple con un nivel determinado de caudal establecido por Breeam.
Produit conforme à un niveau de débit spécifique établi par Breeam.
 Product that meets a specific flow rate level established by Breeam.



BSC 3	6 l/m	6 l/m	8 l/m	8 l/m
BSC 4	5 l/m	5 l/m	8 l/m	8 l/m
BSC 5	3 l/m	3 l/m	6 l/m	6 l/m

Certificaciones internacionales.
International certifications.
 Certifications internationales.

BREEAM® ES



































Para más información sobre configuraciones disponibles y asesoramiento técnico personalizado, consulte con nuestro equipo sin compromiso.

For further information about available configurations and personalised technical advice, please contact our team with no obligation.

Pour plus d'informations sur les configurations disponibles et pour bénéficier d'un conseil technique personnalisé, veuillez consulter notre équipe sans engagement.

Iconografía

Iconography.
Iconographie.

	Unidades por caja. <i>Units per case.</i> <i>Unités par caisse.</i>		Número de posiciones del maneral de ducha. <i>Number of positions of the shower handle.</i> <i>Nombre de positions de la douchette.</i>		Diámetro del cartucho cerámico. <i>Ceramic cartridge diameter.</i> <i>Diamètre de la cartouche céramique.</i>		Rociador de ducha redondo y diámetro. <i>Round shower head and diameter.</i> <i>Pomme de douche ronde et mince et diamètre.</i>		Rociador cuadrado y medidas. <i>Square showerhead and measurements.</i> <i>Pomme de douche carée et mesures.</i>		Aireador Orientable. <i>Orientable Aerator.</i> <i>Aérateur Orientable.</i>		Auto Clean. <i>Auto Clean.</i> <i>Nettoyage Automatique.</i>		Barra regulable. <i>Adjustable bar.</i> <i>Barre réglable.</i>		Cartucho Apertura Agua Fría. <i>Cartridge Opening Cold Water.</i> <i>Cartouche d'ouverture sur l'Eau Froide (C3).</i>		Cartucho Doble Clic. <i>Double Click Cartridge.</i> <i>Cartouche Double Clic (C2).</i>		Cartucho Progresivo. <i>Progressive Cartridge.</i> <i>Cartouche Progressive.</i>		Fb Touch. <i>Fb Touch.</i> <i>Corp Froid.</i>		Inversor Integrado. <i>Inverter Concealed.</i> <i>Inverseur Intégré.</i>		Flexo de ducha 1,70 m. <i>Shower hose 1,70 m.</i> <i>Flexible de douche 1,70 m.</i>		Set de ducha completo. <i>Complete shower set.</i> <i>Ensemble de douche complet.</i>		Sin complementos de ducha. <i>Without shower accessories.</i> <i>Sans accessoires de douche.</i>		Saving Water. <i>Saving Water.</i> <i>Economiser L'eau.</i>		Cartucho termostático. <i>Thermostatic cartridge.</i> <i>Cartouche thermostatique.</i>		Clic-clac. <i>Clic-clac.</i> <i>Clic-clac.</i>		Desagüe automático. <i>Pop-up.</i> <i>Vidage automatique.</i>		Desagüe automático PVC. <i>Desagüe automático PVC.</i> <i>Desagüe automático PVC.</i>		Stop Safe. <i>Stop Safe.</i> <i>Arrêter en Toute Sécurité.</i>		Ubicación célula fotoeléctrica. <i>Photoelectric cell location.</i> <i>Emplacement de cellule photoélectrique.</i>		Alimentación dual, red eléctrica o pilas AA R6. <i>Dual power, mains or AA R6 batteries.</i> <i>Double alimentation, réseau électrique ou piles AA R6.</i>		Grifo extraíble. <i>Kitchen pull-out rinse mixer tap.</i> <i>Mitigeur de cuisine avec douchette extractible.</i>		Grifo preparado para osmosis. <i>Robinets d'eau potable filtrée.</i> <i>Reverse osmosis faucets.</i>		Grifo abatible. <i>Folding tap.</i> <i>Robinet rabattable.</i>		Incluye caja empotrada de conexión. <i>Includes recessed connection box.</i> <i>Box de raccordement inclus.</i>		Certificado ACS. <i>ACS certification.</i> <i>Attestation ACS.</i>		Certificado AENOR. <i>AENOR certification.</i> <i>Attestation AENOR.</i>		Producto certificado por el departamento de Medio Ambiente. <i>Product certified by the Department of Environment.</i> <i>Produit certifié par le Département de l'Environnement.</i>		Producto que cumple con un nivel determinado de caudal establecido por Breeam. <i>Produit conforme à un niveau de débit spécifique établi par Breeam.</i> <i>Product that meets a specific flow rate level established by Breeam.</i>
---	---	---	---	---	---	---	---	---	--	---	---	--	--	---	--	---	---	---	--	---	--	---	---	---	--	---	---	---	---	---	--	---	---	---	--	---	--	---	---	---	---	---	--	---	--	--	--	---	--	---	--	---	--	---	---	---	--	---	--	---	---	---	---

Acabados.

Finishes.
Finitions.

	PÁGINA							
		Cromo Chrome Chromé	Negro mate Matte black Noir mat	Oro cepillado PVD Brushed gold PVD Or brossé PVD	Níquel cepillado PVD Brushed nickel PVD Nickel brossé PVD	Cobre cepillado PVD Brushed copper PVD Cuvre brossé PVD	Black chrome PVD Black chrome PVD Noir chromé PVD	Blanco mate Matte white Blanc mat
		C	N	G	NQ	RG	BC	BM
Tube	28							-
Columnas	142							-
Complementos	194							-
Termostáticas	154							-
Especiales	186							-
Aston	80				-		-	-
Duna	86				-		-	-
Cocinas	130				-		-	-
Inoa	64				-		-	-
Ares	60			-	-	-	-	
Eros	70			-	-	-	-	-
Luca	92			-	-	-	-	-
Ebro	98			-	-	-	-	-
Impala	190			-	-	-	-	-
Apolo	46		-	-	-	-	-	-
Moon	50		-	-	-	-	-	-
Iris	42		-	-	-	-	-	-
One	52		-	-	-	-	-	-
Kali	56		-	-	-	-	-	-
Ice	78		-	-	-	-	-	-
Neos	74		-	-	-	-	-	-
Trianon MX	102		-	-	-	-	-	-
Back	106		-	-	-	-	-	-
Play	110		-	-	-	-	-	-
Seis	114		-	-	-	-	-	-
Duo	116		-	-	-	-	-	-
Jet	120		-	-	-	-	-	-
Cinco	126		-	-	-	-	-	-
Temporizadas	180		-	-	-	-	-	-
Sensor	184		-	-	-	-	-	-
Pisa	176		-	-	-	-	-	-
Verona	172		-	-	-	-	-	-
Antique	170		-	-	-	-	-	-
Classic	168		-	-	-	-	-	-
Terra	164		-	-	-	-	-	-

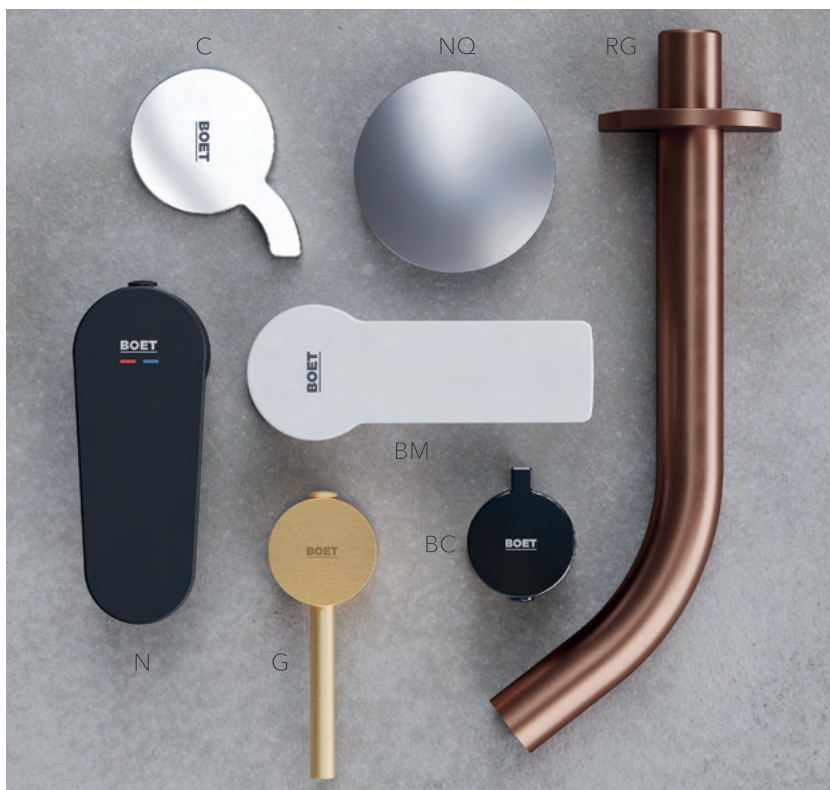

Índice general.

Index.

Indice.

COLECCIONES 26	Tube	28	BIMANDO 164	Terra	166
	Iris	42		Classic	168
	Apolo	46		Antique	170
	Moon	50		Verona	172
	One	52		Pisa	176
	Kali	56	COLECTIVIDADES 180	Temporizadas	182
	Ares	60		Sensor	184
	Inoa	64		Especiales	186
	Eros	70		Impala	190
	Neos	74	COMPLEMENTOS 194	Rociadores	195
	Ice	78		Brazos de ducha	197
	Aston	80		Mangos de ducha	198
	Duna	86		Flexos	201
	Luca	92		Desagües	201
	Ebro	98		Sifones	201
	Trianon MX	102		Kits de ducha	202
	Back	106	RECAMBIOS 204		
	Play	110	SHOWROOM 238	Expositores de pie	239
	Seis	114		Expositores peana	243
	Duo	116		Expositores de sobremesa	243
	Jet	120	PROYECTOS HOTELEROS 244		
	Cinco	126	CONDICIONES COMERCIALES 246		
COCINAS 130					
COLUMNAS 142					
TERMOSTÁTICAS 154	Empotradas	156			
	A pared	159			
	Columnas termostáticas	160			

BOET

Contacto
Contact



Índice colecciones.

Index.
Indice.



Tube 28



Iris 42



Apolo 46



Moon 50



One 52



Kali 56



Ares 60



Inoa 64



Eros 70



Neos 74



Ice 78



Aston 80



Duna 86



Luca 92



Ebro 98



Trianon MX 102



Back 106



Play 110



Seis 114



Duo 116



Jet 120



Cinco 126

Colección TUBE



Diseño, limpio y minimalista, inspirado en conceptos vanguardistas, industriales y Bauhaus.

Tube is a collection of clean and minimalist design faucets, inspired by avant-garde, industrial, and Bauhaus concepts.

Tube est une collection de robinetterie au design épuré et minimaliste, inspirée par des concepts avant-gardistes, industriels et Bauhaus.





TUBE

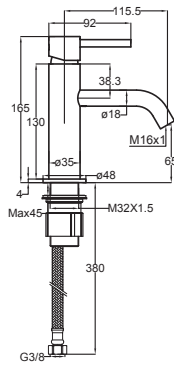

Monomando para lavabo con apertura en frío y caudal 5 l/m.
Single-lever basin mixer with cold start and 5 l/m flow rate.
Mitigeur pour lavabo monobloc laiton, avec C3 et débit 5 l/m.

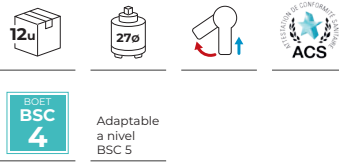

REFERENCIA	PVP
40107	99,69 €
40107/N	103,63 €
40107/NQ	129,16 €
40107/G	129,16 €
40107/BC	133,24 €
40107/RG	129,16 €

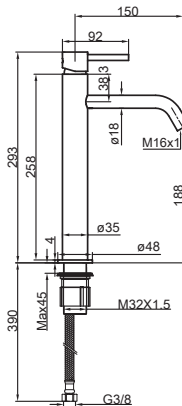

Monomando para lavabo XL con apertura en frío y caudal 5 l/m.
XL Single-lever basin mixer with cold start and 5 l/m flow rate.
Mitigeur haut pour lavabo monobloc laiton, avec C3 et débit 5 l/m.

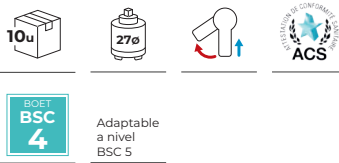

REFERENCIA	PVP
40109	149,80 €
40109/N	164,42 €
40109/NQ	199,80 €
40109/G	199,80 €
40109/BC	210,94 €
40109/RG	199,80 €

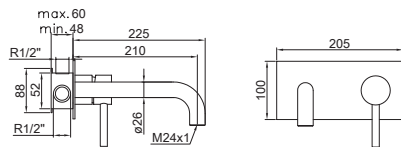

Monomando empotrado para lavabo con placa. Caudal de 12 l/m.
Wall mounted single-lever basin mixer with backplate and 12 l/m flow rate.
Mitigeur encastré pour lavabo laiton avec plaque. Box de raccordement. Débit 12 l/m.



REFERENCIA	PVP
40110	459,23 €

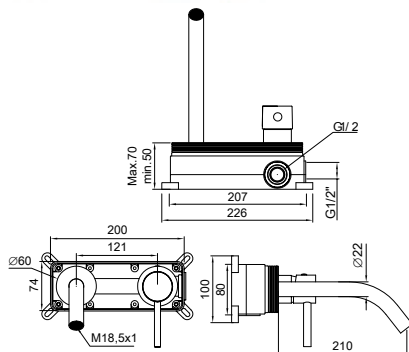

Monomando empotrado para lavabo con apertura en frío y caudal 6,9 l/m.
Wall mounted single-lever basin mixer with cold start and 6,9 l/m flow rate.
Mitigeur laiton encastré pour lavabo. Box de raccordement. Débit 6,9 l/m.



REFERENCIA	PVP
40112	185,68 €
40112/N	203,79 €
40112/NQ	230,46 €
40112/G	230,46 €
40112/BC	243,32 €
40112/RG	230,46 €



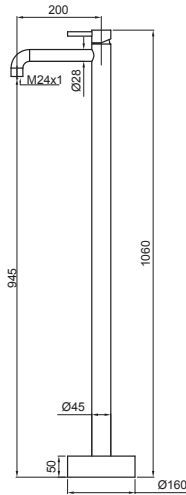





Monomando montado en suelo para lavabo tótem, altura 1.073 mm con caudal 7,8 l/m.

Single-lever mixer for freestanding basin with 7,8 l/m flow rate. Height 1.073 mm.

Mitigeur lavabo autoportant laiton, hauteur 1.073 mm. Box de raccordement. Débit 7,8 l/m.



REFERENCIA	PVP
------------	-----

 40105	419,43 €
 40105/NQ	498,04 €
 40105/G	498,04 €
 40105/BC	500,15 €
 40105/RG	499,58 €

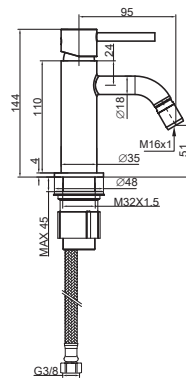





Monomando bidé con rótula giratoria y apertura en frío. Caudal 7,5 l/m.

Single-lever bidet mixer with directional aerator and 7,5 l/m flow rate.

Mitigeur bidet laiton avec rotule orientable et C3. Débit 7,5 l/m.



REFERENCIA	PVP
------------	-----

 40227	95,65 €
 40227/N	104,11 €
 40227/NQ	124,97 €
 40227/G	124,97 €
 40227/BC	132,44 €
 40227/RG	124,97 €

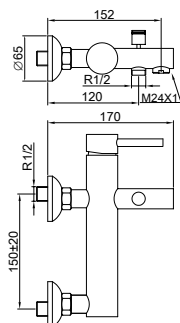



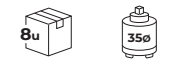

Monomando baño y ducha con inversor automático y caudal de 10,2 l/m, con accesorios: Flexo INOX de 1,7 m, soporte orientable y mango de ducha ABS autoclean.

Single-lever bath-shower mixer, 10,2 l/m flow rate, with 1,7 m INOX flexible hose, automatic diverter and anti-limescale shower handset.

Mitigeur bain douche laiton. Débit 10,2 l/m. Flexible INOX 1,7 m, support orientable et douchette anticalcaire.



REFERENCIA	PVP
------------	-----

 40555	276,35 €
 1,70m	
	
	
 40555/0	245,79 €



TUBE

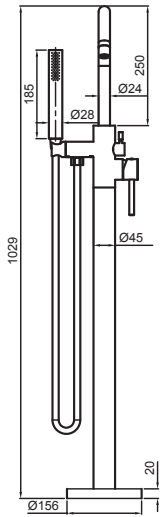





Grifo monomando para bañera exenta a suelo, con dos vías, baño y ducha, con flexo INOX de 1,5 m, soporte con toma de agua y maneral de ducha.

Single-lever mixer for freestanding bath with two outlets. Accessories: 1,5 m INOX flexible hose and shower handset.

Mitigeur baignoire autoportant laiton. Box de raccordement. Flexible INOX 1,5 m, support avec prise d'eau et douchette.



REFERENCIA PVP

	40558	470,18 €
	40558/NQ	588,11 €
	40558/G	588,11 €
	40558/BC	588,11 €
	40558/RG	588,11 €

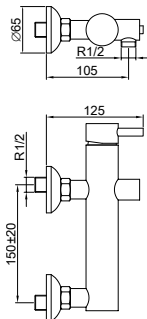





Monomando de ducha con caudal de 12 l/m y accesorios: flexible INOX de 1,7 m, soporte orientable y mango de ducha ABS autoclean.

Single-lever mixer for shower, 12 l/m flow rate, with 1,7 m INOX flexible hose and anti-limescale shower handset.

Mitigeur douche laiton, avec flexible INOX 1,7 m, douchette, support orientable et douchette anticalcaire.



REFERENCIA PVP

	40424	270,44 €
		1,70m
		1
		
	40424/0	246,11 €

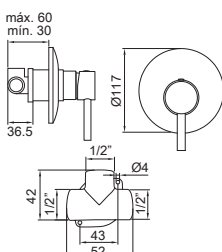

Monomando ducha empotrado de 1 vía con caudal de 17 l/m, sin accesorios.

Wall mounted single-lever shower mixer 17 l/m flow rate, with 1 outlet. Without shower handset.

Mitigeur douche encastrée avec une sortie, débit 17 l/m, sans accessoires.



REFERENCIA PVP

	40425	127,39 €
---	-------	----------

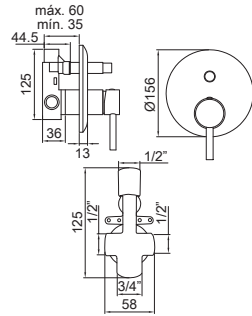

Monomando de ducha empotrado con 2 vías para rociador y mango de ducha ABS autoclean, con caudal de 14,3 l/m. Sin accesorios.

Wall mounted single-lever shower mixer with 2 ways, 14,3 l/m flow rate. Without shower handset.

Mitigeur douche encastrée avec deux sorties, débit 14,3 l/m sans accessoires.



REFERENCIA	PVP
------------	-----

40556	207,96 €
40556/N	212,52 €
40556/NQ	234,25 €
40556/G	234,25 €
40556/BC	245,43 €
40556/RG	245,43 €



Pack monomando ducha empotrada de 2 vías y caudal de 14,3 l/m, con accesorios: brazo de pared, rociador redondo Ø 25 cm, soporte con toma de agua, flexo y maneral de ducha.

Bathroom tap pack wall mounted Single-lever with 2 ways and 14,3 l/m flow rate. Shower arm, round fixed INOX overhead shower head Ø 25 cm, shower outlet elbow and handset holder, shower hose and handset.

Pack mitigeur pour douche encastrée, avec 2 sorties. Box de raccordement. Bras mural, tête de pluie INOX ronde Ø 25 cm coude de raccordement mural avec support, flexible de douche et douchette.

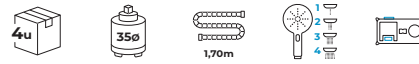

REFERENCIA	PVP
------------	-----

Pack Tube	298,45 €
Pack Tube Negro	350,75 €
Pack Tube/NQ	415,75 €
Pack Tube/G	415,75 €
Pack Tube/BC	426,93 €
Pack Tube/RG	426,93 €

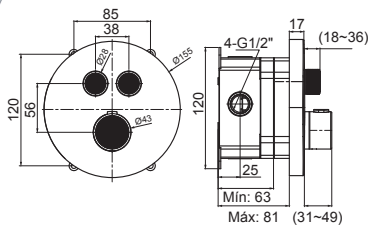

Grifería termostática empotrada de ducha con dos vías de caudal regulable, sistema de tope de temperatura a 38°C y sistema de corte de seguridad.

Concealed thermostatic shower mixer with two adjustable flow outlets, 38°C temperature limit stop system and safety shut-off system.

Robinetterie thermostatique de douche encastrée avec deux voies à débit réglable, système de butée de température à 38 °C et système de coupure de sécurité.



REFERENCIA	PVP
------------	-----

52148	287,67 €
52148/N	299,45 €
52148/G	354,64 €
52148/RG	385,35 €

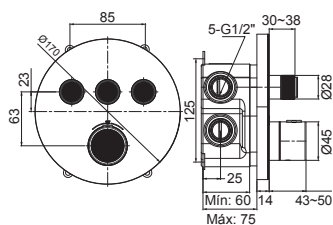

Grifería termostática empotrada de ducha con tres vías de caudal regulable, sistema de tope de temperatura a 38° y sistema de corte de seguridad.

Concealed thermostatic shower mixer with three adjustable flow outlets, 38°C temperature limit stop system and safety shut-off system.

Robinetterie thermostatique de douche encastrée avec trois voies à débit réglable, système de butée de température à 38 °C et système de coupure de sécurité.



REFERENCIA	PVP
------------	-----

52149	370,30 €
52149/N	379,96 €
52149/G	489,50 €
52149/RG	499,80 €

TUBE



Termolux: Grifería termostática empotrada de ducha con dos vías de caudal regulable, sistema de tope de temperatura a 38°C y sistema de corte de seguridad, rociador con brazo de pared, flexo, soporte y mango de ducha.

Concealed thermostatic shower mixer with two adjustable flow outlets, 38°C temperature limit stop system and safety shut-off system, overhead shower with wall-mounted arm, hose, holder and hand shower.

Robinetterie thermostatique de douche encastrée avec deux voies à débit réglable, système de butée de température à 38 °C et système de coupure de sécurité, pomme de tête avec bras mural, flexible, support et douchette.



REFERENCIA	PVP
Pack 52148/1	378,13 €
Pack 52148/1/N	437,68 €
Pack 52148/1/G	536,14 €
Pack 52148/1/RG	585,40 €



Termolux: Grifería termostática empotrada de ducha con dos vías de caudal regulable, sistema de tope de temperatura a 38°C y sistema de corte de seguridad, rociador con brazo de techo, flexo, soporte y mango de ducha.

Concealed thermostatic shower mixer with two adjustable flow outlets, 38°C temperature limit stop system and safety shut-off system, overhead shower with ceiling-mounted arm, hose, holder and hand shower.

Robinetterie thermostatique de douche encastrée avec deux voies à débit réglable, système de butée de température à 38 °C et système de coupure de sécurité, pomme de tête avec bras plafond, flexible, support et douchette.



REFERENCIA	PVP
Pack 52148/2	378,13 €
Pack 52148/2/N	437,68 €
Pack 52148/2/G	536,14 €
Pack 52148/2/RG	585,40 €



Termolux: Grifería termostática empotrada de ducha con dos vías de caudal regulable, sistema de tope de temperatura a 38°C y sistema de corte de seguridad, rociador con brazo de pared, flexo, soporte con mango de ducha y caño de bañera.

Concealed thermostatic shower mixer with two adjustable flow outlets, 38°C temperature limit stop system and safety shut-off system, overhead shower with wall-mounted arm, hose, holder with hand shower and bath spout.

Robinetterie thermostatique de douche encastrée avec deux voies à débit réglable, système de butée de température à 38 °C et système de coupure de sécurité, pomme de tête avec bras mural, flexible, support avec douchette et bec de baignoire.



REFERENCIA	PVP
Pack 52149/1	460,76 €
Pack 52149/1/N	518,19 €
Pack 52149/1/G	671,80 €
Pack 52149/1/RG	681,30 €







Termolux: Grifería termostática empotrada de ducha con dos vías de caudal regulable, sistema de tope de temperatura a 38°C y sistema de corte de seguridad, rociador con brazo de techo, flexo, soporte con mango de ducha y caño de bañera.

Concealed thermostatic shower mixer with two adjustable flow outlets, 38°C temperature limit stop system and safety shut-off system, overhead shower with ceiling-mounted arm, hose, holder with hand shower and bath spout.

Robinetterie thermostatique de douche encastrée avec deux voies à débit réglable, système de butée de température à 38 °C et système de coupure de sécurité, pomme de tête avec bras plafond, flexible, support avec douchette et bec de baignoire.



REFERENCIA	PVP
------------	-----

 Pack 52149/2	460,76 €
 Pack 52149/2/N	518,19 €
 Pack 52149/2/G	671,80 €
 Pack 52149/2/RG	681,30 €

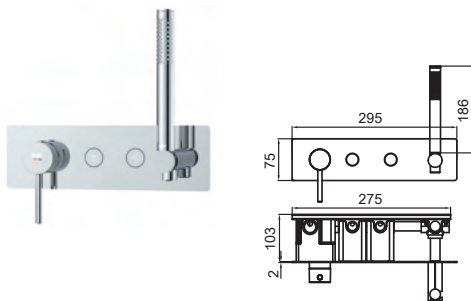





Monomando ducha empotrada push de 2 vías, con placa INOX, flexo y mango de ducha ABS autoclean. Caudal de 12 l/m.

Single-lever for shower with 2 push outlets in backplate. 12 l/m flow rate.

Mitigeur laiton encastré push 2 sorties avec plaque. Box de raccordement. Débit 12 l/m.



REFERENCIA	PVP
------------	-----

 40148	469,05 €
 40148/N	523,58 €
 40148/NQ	704,20 €
 40148/G	704,20 €
 40148/BC	749,97 €







Pack monomando ducha empotrada push de 2 vías y caudal de 12 l/m, con accesorios: brazo de pared, rociador INOX redondo ø 25 cm, soporte integrado con toma de agua, flexo INOX y maneral de ducha ABS autoclean.

Bathroom tap pack wall mounted single-lever, with 2 ways push, 12 l/m flow rate. In wall shower arm, ø 25 cm round fixed overhead INOX shower head, integrated shower outlet elbow and handset holder, shower hose and handset.

Pack mitigeur laiton pour douche encastrée, avec 2 sorties push: bras mural, tête de pluie INOX ronde ø 25 cm, coude de raccordement mural avec support, flexible de douche en acier INOX, et douchette. Box de raccordement.



REFERENCIA	PVP
------------	-----

 Pack 148 Wall	503,42 €
 Pack 148 Wall/N	523,58 €
 Pack 148 Wall/NQ	763,79 €
 Pack 148 Wall/G	763,79 €
 Pack 148 Wall/BC	806,81 €



TUBE



Pack monomando ducha empotrada push de 2 vías y caudal de 12 l/m, con accesorios: brazo de techo, rociador INOX redondo ø 25 cm, soporte integrado con toma de agua, flexo INOX y maneral de ducha ABS autoclean.

Bathroom tap pack wall mounted single-lever, with 2 ways push, 12 l/m flow rate. Top shower arm, ø 25 cm round fixed INOX overhead shower head, integrated shower outlet elbow and handset holder, shower hose and handset.

Pack mitigeur laiton pour douche encastrée, avec 2 sorties push: bras de douche au plafond, tête de pluie INOX ronde ø 25 cm, coude de raccordement mural avec support, flexible de douche INOX, et douchette. Box de raccordement.



REFERENCIA	PVP
Pack 148 Top	503,42 €
Pack 148 Top/N	556,47 €
Pack 148 Top/NQ	755,77 €
Pack 148 Top/G	755,77 €
Pack 148 Top/BC	797,85 €

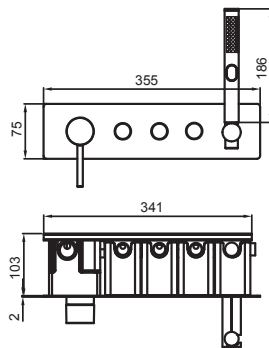

Monomando de ducha empotrado push de 3 vías, con placa INOX, flexo y mango de ducha ABS autoclean. Caudal 12 l/m.

Single-lever for shower with 3 push outlets in backplate. 12 l/m flow rate.

Mitigeur laiton encastré avec push 3 sorties. Avec plaque. Box de raccordement. Débit 12 l/m.

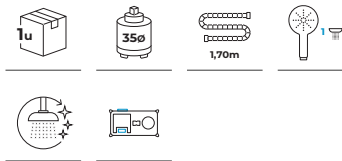

REFERENCIA	PVP
40149	566,84 €
40149/N	615,37 €
40149/NQ	814,92 €
40149/G	814,92 €
40149/BC	862,42 €



Pack monomando ducha empotrada push de 3 vías con placa INOX, caudal 12 l/m y accesorios: rociador-cascada slim cuadrado INOX 304, soporte integrado con toma de agua, flexo y maneral de ducha ABS autoclean.

Bathroom tap pack top mounted single-lever with 3 ways push: Slim stainless steel INOX 304 squared waterfall shower head, integrated shower outlet elbow and handset holder, shower hose and handset. 12 l/m flow rate.

Pack mitigeur laiton pour douche encastrée, avec 3 sorties push avec plaque. Débit 12 l/m. Pomme de douche pluie et cascade carrée INOX 304, coude de raccordement mural avec support, flexible de douche en acier INOX, et douchette. Box de raccordement.

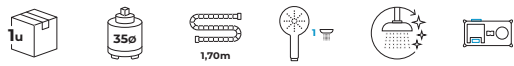

REFERENCIA	PVP
Pack 149/C	973,68 €
Pack 149/NC	1.100,00 €
Pack 149/NQ	1.288,42 €
Pack 149/G	1.288,42 €
Pack 149/BC	1.334,74 €





Pack monomando ducha empotrada push de 3 vías con placa INOX, caudal 12 l/m y accesorios: rociador-cascada slim redondeado INOX 304, soporte integrado con toma de agua, flexo y maneral de ducha ABS autoclean.

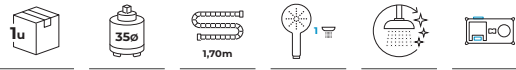

Bathroom tap pack top mounted Single-lever with 3 ways push: Slim stainless steel 304 rounded waterfall shower head, integrated shower outlet elbow and handset holder, shower hose and handset. 12 l/m flow rate.

Pack mitigeur laiton pour douche encastrée, avec 3 sorties push avec plaque. Débit 12 l/m. Pomme de douche pluie et cascade ronde INOX 304, coude de raccordement mural avec support, flexible de douche en acier INOX, et douchette. Box de raccordement.



Vídeo de instalación
Installation video
Vidéo d'installation

REFERENCIA **PVP**

-  Pack 149/R **951,58 €**
-  Pack 149/NR **1.068,42 €**

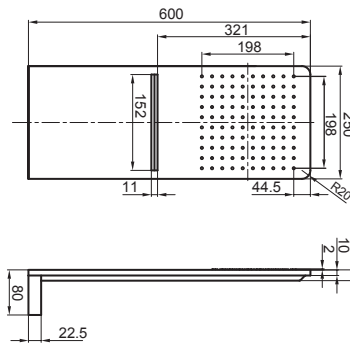





Rociador con cascada slim cuadrado de dos vías cuadrado INOX 304 y caudal 11 l/m.

Slim square overhead shower with dual outlet and waterfall function, made of INOX 304. Flow rate 11 l/min.

Pomme de douche pluie et cascade en acier INOX 304 carrée. Débit 11 l/m.



REFERENCIA **PVP**

-  4061 **630,71 €**
-  4061/N **662,21 €**
-  4061/NQ **784,91 €**
-  4061/G **784,91 €**
-  4061/BC **784,91 €**

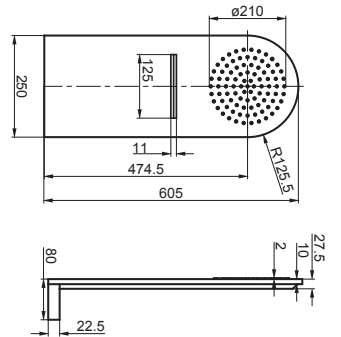

Rociador con cascada slim de dos vías redondeado INOX 304 y caudal 11 l/m.

Slim rounded overhead shower with dual outlet and waterfall function, made of INOX 304. Flow rate 11 l/min.

Pomme de douche pluie et cascade en acier INOX 304 ronde. Débit 11 l/m.



REFERENCIA **PVP**

-  4062 **604,42 €**
-  4062/N **637,68 €**

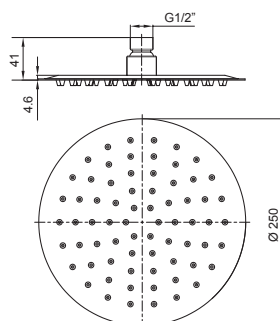







Rociador ducha INOX slim ø 25 cm con sistema anticalcáreo.

Stainless steel slim shower head ø 25 cm with anti-limescale system.

Pomme de douche fine en acier inoxydable ø 25 cm avec système anticalcaire.



REFERENCIA **PVP**

-  4084/25 **44,66 €**
-  4084/25/N **57,40 €**
-  4084/25/NQ **63,09 €**
-  4084/25/G **63,09 €**
-  4084/25/BC **66,40 €**
-  4084/25/RG **65,20 €**

TUBE







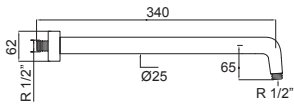

Brazo de ducha fijo de latón, tubular a pared, 34 cm de largo.

Brass fixed shower arm 34 cm.

Bras de douche fix laiton, longueur 34 cm.



REFERENCIA	PVP
------------	-----

 4013	35,95 €
 4013/N	39,74 €
 4013/NQ	51,93 €
 4013/G	51,93 €
 4013/BC	53,81 €
 4013/RG	52,90 €







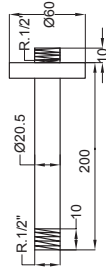

Brazo fijo de ducha de latón para techo, 20 cm de largo.

Brass fixed top shower arm 20 cm.

Bras de douche fixe laiton, longueur 20 cm.



REFERENCIA	PVP
------------	-----

 4096	43,32 €
 4096/N	43,84 €
 4096/NQ	43,91 €
 4096/G	43,91 €
 4096/BC	44,85 €
 4096/RG	44,20 €







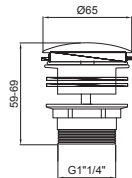

Desagüe pulsador rápido de latón clic-clac con rosca de 1" 1/4.

Brass clic-clac pop-up waste with 1" 1/4 thread.

Bonde laiton clic-clac, 1" 1/4.



REFERENCIA	PVP
------------	-----

 4025	18,37 €
 4025/N	20,21 €
 4025/NQ	22,78 €
 4025/G	22,78 €
 4025/BC	22,78 €
 4025/RG	22,78 €



Flexo de ducha en acero INOX (AISI 304) 1,70 m, tuercas latón 1/2\".







1.70 m stainless steel (AISI 304) shower hose with brass 1/2" nuts.

Flexible INOX (AISI 304) 1,70m.

Écrous laiton 1/2\".



REFERENCIA	PVP
------------	-----

 4033	11,03 €
 4033/N	18,63 €
 4033/NQ	30,87 €
 4033/G	30,87 €
 4033/BC	34,66 €
 4033/RG	32,84 €

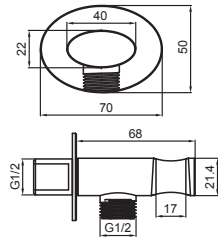

Soporte de latón para mango de ducha con toma de agua, roscas 1/2", caudal 20 l/m.
Shower outlet elbow with holder, 1/2" threads.
Flow rate: 20 l/min.

Support de douche mural en laiton avec prise d'eau intégrée. Écrous 1/2". Débit 20 l/m.

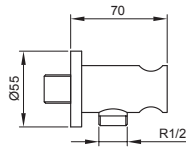

REFERENCIA	PVP
4047	41,81 €
4047/N	43,95 €
4047/NQ	49,75 €
4047/G	49,75 €
4047/BC	50,52 €
4047/RG	50,25 €

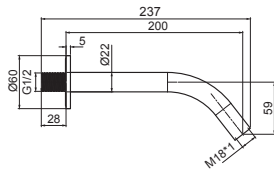

Caño para bañera redondo.
Round spout for bathtub.
Bec rond pour baignoire.



REFERENCIA	PVP
SP-010	23,95 €
SP-010/N	29,59 €
SP-010/NQ	41,65 €
SP-010/G	41,67 €
SP-010/BC	45,68 €
SP-010/RG	45,68 €

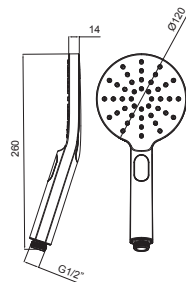

Mango de ducha ABS con pulsador de 4 posiciones y sistema autoclean.
ABS showerhead with 4-position push button and anti-limescale system.
Douchette ABS à 4 positions, anticalcaire.



REFERENCIA	PVP
4086	15,43 €
4086/N	28,26 €
4086/NQ	28,69 €
4086/G	28,69 €
4086/BC	30,12 €
4086/RG	29,50 €

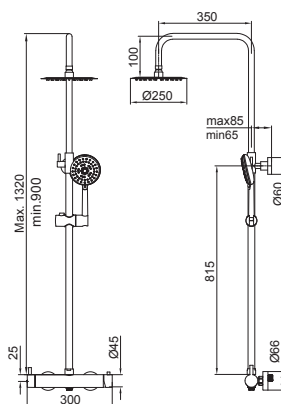
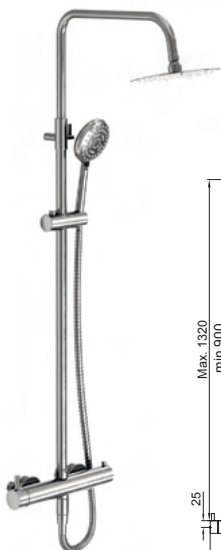

Tube: Columna de ducha monomando telescópica, inversor integrado de 2 posiciones, con flexo, rociador redondo INOX ø 25 cm Slim y mango ducha ABS autoclean.

Single-lever round slide bar shower mixer kit, built-in diverter, ABS auto clean shower and round inox 3 mm overhead.

Colonne de douche extensible, avec mitigeur, inverseur intégré 2 sorties, pomme de douche ronde inox autoclean, flexible et douchette anti calcaire.



REFERENCIA	PVP
82430/3	278,59 €
82430/3/N	325,40 €
82430/3/NQ	529,35 €
82430/3/G	529,35 €
82430/3/BC	615,89 €
82430/3/RG	585,42 €

TUBE

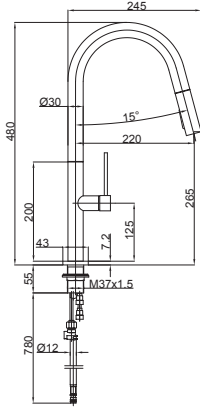

Monomando de cocina con caño alto, flexo extraíble, duchita y conexión imantada. Con apertura en frío y caudal 6,9 l/m.

Single-lever kitchen mixer with high spout, pull-out hose, hand shower and magnetic connection. Cold-start system and 6.9 l/min flow rate.

Mitigeur évier laiton, cartouche C3, avec bec extractible. Support de douchette magnétique. Débit 6,9 l/m.



REFERENCIA	PVP
------------	-----

 40673	162,84 €
---	----------

 40673/N	178,84 €
---	----------

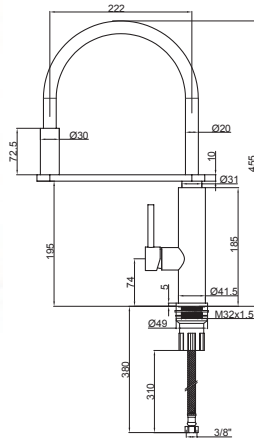

Monomando de cocina cromado con caño giratorio flexible de silicona suave. Caudal 6,2 l/m.

Kitchen single-lever mixer with flexible swivel spout made of soft silicone. Flow rate 6.2 l/min.

Mitigeur cuisine laiton avec bec siliconé flexible et doux au toucher. Débit 6,2 l/m.



REFERENCIA	PVP
------------	-----

 82693/A	235,19 €
---	----------

 82693/B	235,19 €
---	----------

 82693/N	235,19 €
---	----------

 82693/R	235,19 €
---	----------





Colección IRIS



La colección Iris interpreta el agua a través de un diseño fluido y arquitectónico, creando una sensación de equilibrio entre dinamismo y serenidad. Incorpora acabados en cromo y apertura en frío.

The Iris collection interprets water through a fluid, architectural design, creating a sense of balance between dynamism and serenity. Features chrome finish and cold-start system.

La collection Iris interprète l'eau à travers un design fluide et architectural, créant une sensation d'équilibre entre dynamisme et sérénité. Proposée avec finition chrome et ouverture sur l'eau froide (C3).





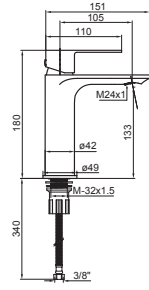

Monomando lavabo XL con apertura en frío.

XL single-lever basin mixer with cold start.

Mitigeur lavabo haut avec C3.



REFERENCIA PVP



10109

121,52 €

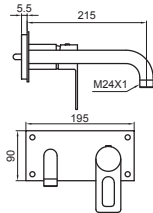

Monomando empotrado para lavabo con placa.

Wall mounted single-lever basin mixer with backplate.

Mitigeur encastré pour lavabo avec plaque.



REFERENCIA PVP



10110

473,43 €

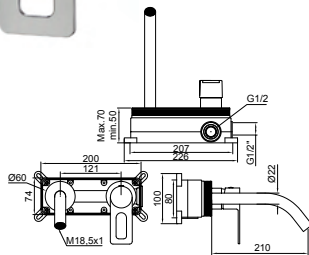

Monomando empotrado para lavabo sin placa con apertura en frío. Caudal de 6,9 l/m.

Wall mounted single-lever basin mixer with cold start.

Mitigeur encastré pour lavabo sans plaque avec C3.



REFERENCIA PVP



10112

191,43 €

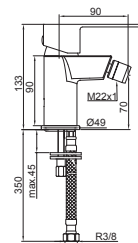

Monomando bidé con rótula giratoria.

Single-lever bidet mixer with directional aerator.

Mitigeur bidet avec rotule orientable.

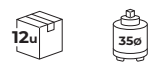

REFERENCIA PVP



10227

81,61 €

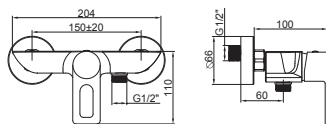

Monomando ducha con soporte orientable y mango de ducha ABS autoclean.

Single-lever with automatic shower diverter and anti-limescale shower handset.

Mitigeur douche avec douchette anti calcaire et support orientable.

REFERENCIA PVP

10424 | 124,24 €



REFERENCIA PVP

10424/0 | 107,99 €

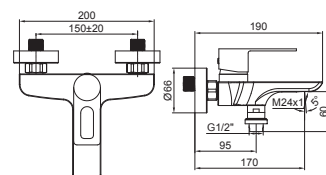
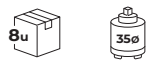

Monomando baño y ducha con inversor automático, soporte orientable, flexo y mango de ducha ABS autoclean.

Single-lever automatic bath-shower diverter with flexible hose, shower holder and anti-limescale shower handset.

Mitigeur bain-douche. Inverseur automatique, flexible et douchette anti calcaire. Support orientable.

REFERENCIA PVP

10555 | 162,51 €



REFERENCIA PVP

10555/0 | 146,32 €

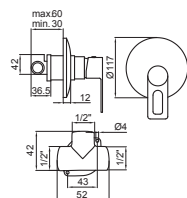

Monomando ducha empotrado de 1 vía.

Wall mounted single-lever shower mixer with 1 outlet.

Mitigeur douche encastrable, 1 sortie.

REFERENCIA PVP

10425 | 98,39 €

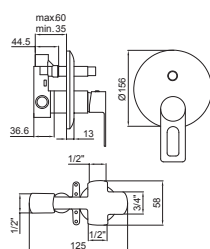

Monomando ducha empotrado con 2 vías.

Wall mounted 2 outlets shower single-lever mixer.

Mitigeur douche encastrable avec 2 sorties.

REFERENCIA PVP

10556 | 188,84 €



Colección APOLO



Diseño único de formas curvas que evocan elegantes piezas escultóricas en acabado cromo, transformando el baño en un entorno privilegiado. Incorpora monomando de apertura progresiva en temperatura y caudal.

Unique design with curved shapes that evoke elegant sculptural pieces in chrome finish, transforming the bathroom into an exclusive space. Features a single-lever mixer with progressive opening for temperature and flow.

Design unique aux formes courbes évoquant de élégantes pièces sculpturales en finition chromée, transformant la salle de bain en un espace privilégié. Équipée d'un mitigeur monocommande à ouverture progressive en température et en débit.





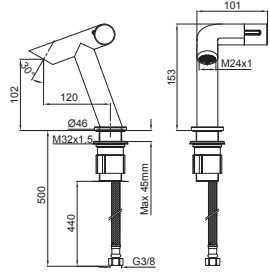

Monomando lavabo con apertura progresiva en frío y aireador orientable. Caudal 6,6 l/m.

Single-lever basin mixer with progressive cold start system and directional aerator. Flow rate 6,6 l/m.

Mitigeur lavabo avec ouverture progressive sur l'eau froide et aérateur orientable. Débit 6,6 l/m.

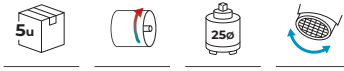

REFERENCIA PVP

22107 | 149,55 €

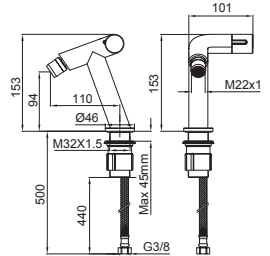

Monomando con apertura progresiva en frío para bidé con rótula giratoria. Caudal 6,3 l/m.

Single-lever bidet mixer with progressive cold start and directional aerator. Flow rate 6,6 l/m.

Mitigeur bidet avec ouverture progressive sur l'eau froide et rotule orientable. Débit 6,3 l/m.

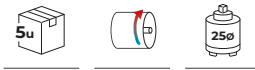

REFERENCIA PVP

22227 | 149,55 €

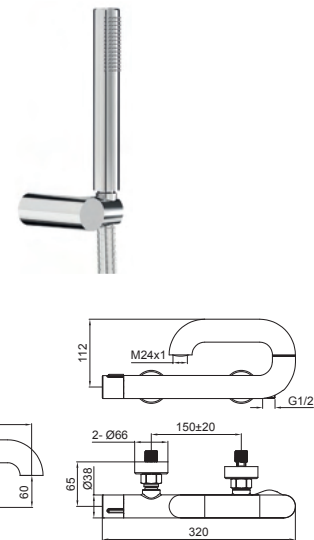

Monomando de apertura progresiva en frío para baño y ducha. Inversor automático, aireador orientable, flexo y mango de ducha autoclean. Caudal 11,7 l/m.

Bath-shower single-lever with progressive cold start and automatic diverter. With flexible and anti-limescale shower handset. Flow rate 11,7 l/m.

Mitigeur bain-douche avec ouverture progressive sur l'eau froide, inverseur automatique et aérateur orientable. Flexible et douchette anti calcaire. Débit 11,7 l/m.



REFERENCIA PVP

22555 | 313,59 €

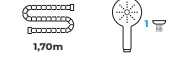

REFERENCIA PVP

22555/0 | 303,84 €



Monomando de apertura progresiva en frío para ducha, con flexible, soporte orientable y mango de ducha autoclean. Caudal 6,3 l/m.

Shower single-lever with progressive cold start and automatic diverter. With flexible and anti-limescale shower handset. Flow rate 6,3 l/m.

Mitigeur douche avec ouverture progressive sur l'eau froide, inverseur automatique et aérateur orientable. Flexible et douchette anti calcaire. Débit 6,3 l/m.



REFERENCIA PVP

22424 | 224,03 €

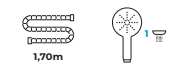

REFERENCIA PVP

22424/0 | 214,28 €





Colección MOON



Diseño único e irrepitible que fascina por su belleza simple y su personalidad tecnológica. Incorpora un innovador grifo de apertura progresiva y aireador orientable. Acabados en cromo.

Unique and distinctive design that captivates with its simple beauty and technological character. Features an innovative progressive-opening mixer and adjustable aerator. Chrome finish.

Design unique et distinctif qui séduit par sa beauté simple et son caractère technologique. Équipé d'un mitigeur à ouverture progressive et d'un aérateur orientable. Finition chrome.



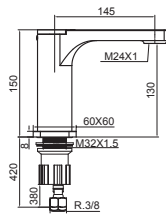

Monomando lavabo con apertura progresiva en frío de 90° y aireador orientable.

Single-lever basin mixer with progressive cold start system and directional aerator.

Mitigeur lavabo avec C3 et aérateur orientable.



REFERENCIA PVP

29107 | 144,70 €

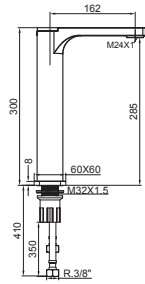

Monomando lavabo XL con apertura progresiva en frío de 90° y aireador orientable.

Single-lever extended height basin mixer, with progressive cold start system and directional aerator.

Mitigeur haut pour lavabo, avec C3 et aérateur orientable.



REFERENCIA PVP

29109 | 223,78 €

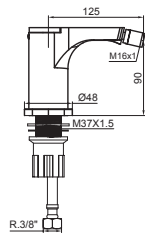

Monomando bidé con apertura progresiva en frío de 90° y rótula giratoria.

Single-lever bidet mixer with progressive cold start and directional aerator.

Mitigeur bidet avec C3 et rotule orientable.



REFERENCIA PVP

29227 | 113,19 €

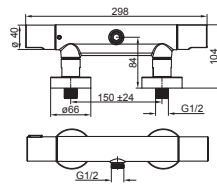

REFERENCIA PVP

44424 | 184,02 €

Mezclador termostático para ducha con sistema cool touch, sistema de tope de temperatura a 38°C y sistema de corte de seguridad. Sin complementos.

Thermostatic shower mixer with cool touch system, safety stop at 38°C and supply fail protection. without accessories.

Mitigeur thermostatique pour douche avec système cool touch, butée de confort à 38°C et protection contre les pannes d'alimentation. Sans accessoires.



Colección ONE



Elegancia contemporánea, estilo atemporal con marcada personalidad. Rendimiento excepcional. Incorpora apertura en frío y aireador orientable. Acabados en cromo.

Contemporary elegance and timeless style with a strong personality. Exceptional performance. Features cold-start opening and adjustable aerator. Chrome finish.

Élégance contemporaine et style intemporel au caractère affirmé. Performance exceptionnelle. Comprend une ouverture sur l'eau froide (C3) et un aérateur orientable. Finition chrome.







Monomando baño y ducha con inversor automático y aireador orientable, soporte orientable, flexo y mango de ducha ABS autoclean.

Single-lever automatic bath-shower diverter with flexible and anti-limescale shower handset.

Mitigeur bain-douche. Flexible, inverseur automatique et douchette anti calcaire. Support orientable.

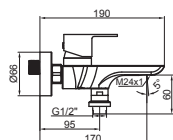

REFERENCIA PVP

44555 | 162,51 €

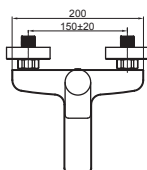
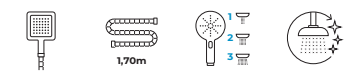

REFERENCIA PVP

44555/0 | 146,32 €



Monomando ducha con flexible, soporte orientable y mango de ducha ABS autoclean.

Single-lever shower mixer with diverter, support, flexible and anti-limescale shower handset.

Mitigeur douche avec flexible, douchette et support orientable.

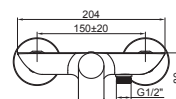
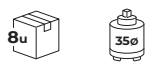

REFERENCIA PVP

44124 | 124,24 €

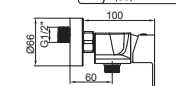
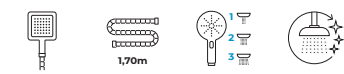

REFERENCIA PVP

44124/0 | 107,99 €

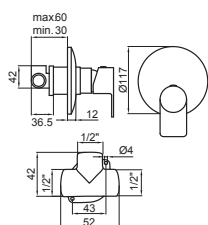

Monomando ducha empotrado con 1 vía.

Wall mounted single-lever shower mixer with 1 outlet.

Mitigeur douche encastrable, 1 sortie.

REFERENCIA PVP

44425 | 98,39 €

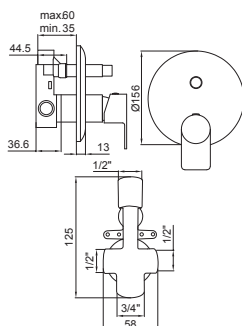

Monomando ducha empotrado con 2 vías.

Wall mounted single-lever shower mixer with 2 outlets.

Mitigeur douche encastrable avec 2 sorties.

REFERENCIA PVP

44556 | 188,84 €



Colección KALI

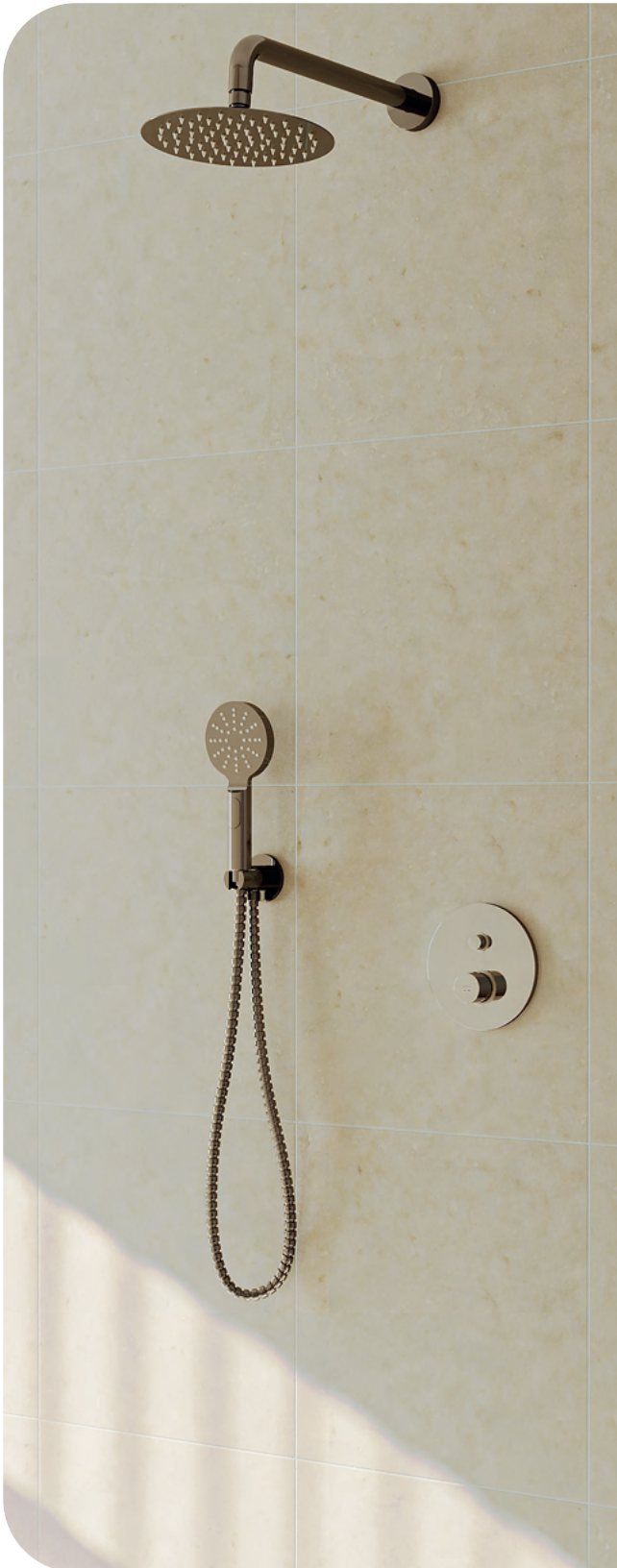

Diseño geométrico y minimalista, definido por formas simples y precisas. Su maneta monomando sin palanca refuerza el carácter sobrio del conjunto. Incorpora apertura en frío y aireador orientable. Acabados en cromo.

Geometric and minimalist design defined by simple, precise shapes. Its single-lever handle without lever reinforces the collection's sober character. Features cold-start opening and adjustable aerator. Chrome finish.

Design géométrique et minimaliste, défini par des formes simples et précises. Sa manette monocommande sans levier renforce le caractère sobre de l'ensemble. Comprend ouverture sur l'eau froide (C3) et aérateur orientable. Finition chrome.





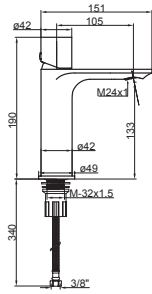

Monomando lavabo XL con apertura en frío y aireador orientable.

XL single-lever basin mixer with cold start and directional aerator.

Mitigeur haut pour lavabo avec C3 et aérateur orientable.



REFERENCIA PVP



13109

109,70 €

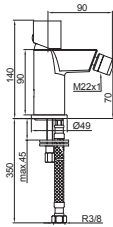

Monomando bidé con rótula giratoria.

Single-lever bidet mixer with directional aerator.

Mitigeur bidet avec rotule orientable.

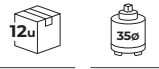

REFERENCIA PVP



13227

78,40 €

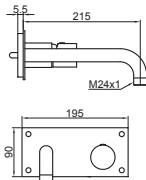

Monomando empotrado para lavabo con placa.

Wall mounted single-lever basin mixer with backplate.

Mitigeur encastré pour lavabo avec plaque.



REFERENCIA PVP



13110

473,43 €

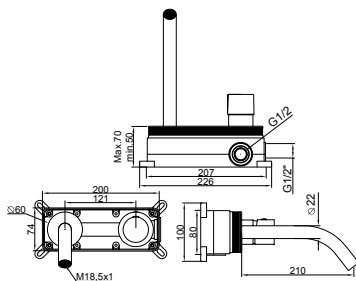

Monomando empotrado para lavabo sin placa con apertura en frío y caudal de 5 l/m.

Wall mounted single-lever basin mixer with cold start. 5 l/m flow.

Mitigeur encastré pour lavabo sans plaque, C3 et débit écologique.

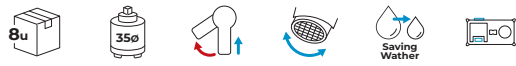

Adaptable a nivel BSC 5



REFERENCIA PVP



13112

191,43 €



Monomando baño y ducha con inversor automático, soporte orientable, flexo y mango de ducha ABS autoclean.

Single-lever automatic bath-shower diverter with flexible and anti-limescale shower handset.

Mitigeur bain-douche. Flexible, inverseur automatique et douchette anti calcaire. Support orientable.

REFERENCIA PVP

13555 | 284,89 €



REFERENCIA PVP

13555/0 | 253,39 €

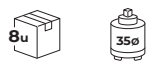

Monomando ducha con flexible, soporte orientable y mango de ducha ABS autoclean.

Single-lever shower with flexible hose, adjustable support and self-cleaning ABS shower handle.

Mitigeur douche, avec flexible, douchette et support orientable.

REFERENCIA PVP

13424 | 278,81 €



REFERENCIA PVP

13424/0 | 246,11 €

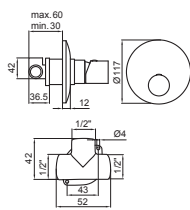

REFERENCIA PVP

13425 | 131,33 €

Monomando ducha empotrado de 1 vía.

Wall mounted single-lever shower mixer with 1 outlet.

Mitigeur douche encastrable, 1 sortie.

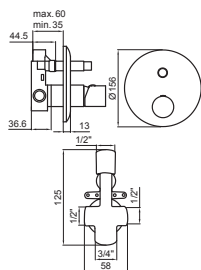

REFERENCIA PVP

13556 | 214,39 €

Monomando ducha empotrado con 2 vías.

Wall mounted single-lever shower mixer with 2 outlets.

Mitigeur douche encastrable avec 2 sorties.



Colección ARES



Diseño de líneas suaves y armoniosas que evocan elegantes formas vegetales. Tres opciones de acabado en cromo, negro mate y blanco. Incorpora aireador orientable.

Design with smooth, harmonious lines that evoke elegant organic shapes. Available in three finishes: chrome, matte black and white. Includes adjustable aerators.

Design aux lignes douces et harmonieuses évoquant de élégantes formes végétales. Disponible en trois finitions : chrome, noir mat et blanc. Équipée d'aérateurs orientables.



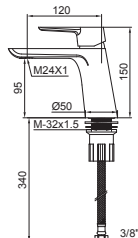

Monomando lavabo con aireador orientable.

Single-lever basin mixer with directional aerator.

Mitigeur lavabo avec aérateur orientable.



REFERENCIA PVP

	34107	98,13 €
	34107/N	120,26 €
	34107/B	120,26 €

REFERENCIA PVP

	34108	121,26 €
--	-------	----------

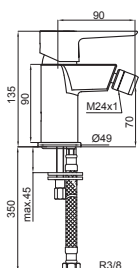

Monomando bidé con rótula giratoria.

Single-lever bidet mixer with directional aerator.

Mitigeur bidet avec rotule orientable.

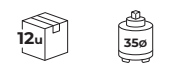

REFERENCIA PVP

	34227	77,84 €
	34227/N	95,39 €
	34227/B	95,39 €

REFERENCIA PVP

	34228	98,55 €
--	-------	---------



Monomando baño y ducha con inversor automático, flexo y mango de ducha ABS autoclean.

Single-lever automatic bath-shower diverter, flexible and anti-limescale shower handset.

Mitigeur bain-douche avec inverseur automatique, flexible et douchette anti calcaire. Support orientable.



REFERENCIA PVP

	34555	162,51 €
	34555/N	208,33 €



REFERENCIA PVP

	34555/0	146,32 €
--	---------	----------



Monomando ducha con flexible, soporte orientable y mango de ducha ABS autoclean.

Single-lever automatic shower diverter and anti-limescale shower handset.

Mitigeur douche avec flexible, douchette et support orientable.



REFERENCIA PVP

	34424	124,24 €
	34424/N	159,28 €



REFERENCIA PVP

	34424/0	107,99 €
--	---------	----------



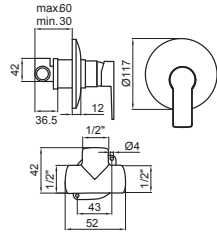

Monomando ducha empotrado de 1 vía.
 Wall mounted single-lever shower mixer with 1 outlet.
 Mitigeur douche encastrable, 1 sortie.



REFERENCIA PVP

34425 | 98,29 €

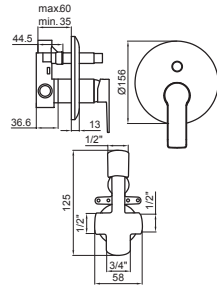

Monomando ducha empotrado con 2 vías.
 Wall mounted single-lever bath-shower mixer with 2 outlets.
 Mitigeur bain-douche encastrable avec 2 sorties.



REFERENCIA PVP

34556 | 188,84 €

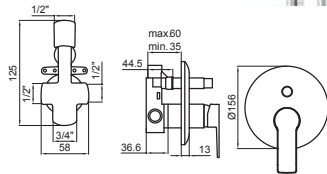

Pack monomando ducha empotrado de 2 vías, con accesorios: brazo de pared, rociador redondo, soporte con toma de agua, flexo y mango de ducha ABS autodeclean.

Bathroom tap pack wall mounted Single-lever with 2 outlets push: shower arm, round fixed overhead shower head, shower outlet elbow and handset holder, shower hose and handset.

Pack pour douche encastrée, avec 2 sorties push: bras mural, tête de pluie ronde, coude de raccordement mural avec support, flexible de douche et douchette.

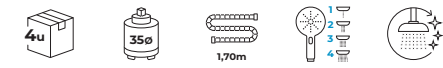

REFERENCIA PVP

Pack 34 Wall | 297,26 €

REFERENCIA PVP

Pack 34 Wall/N | 376,99 €



Video de instalación
 Installation video
 Vidéo d'installation

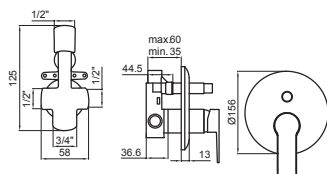

Pack monomando ducha empotrado de 2 vías, con accesorios: brazo de pared, rociador redondo, soporte con toma de agua, flexo y mango de ducha ABS autodeclean.

Bathroom tap pack top mounted Single-lever with 2 outlets push: shower arm, round fixed overhead shower head, shower outlet elbow and handset holder, shower hose and handset.

Pack pour douche encastrée, avec 2 sorties push: bras de douche au toit, tête de pluie ronde, coude de raccordement mural avec support, flexible de douche et douchette.

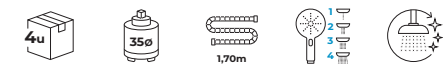

REFERENCIA PVP

Pack 34 top | 299,05 €

REFERENCIA PVP

Pack 34 top/N | 378,78 €



Video de instalación
 Installation video
 Vidéo d'installation

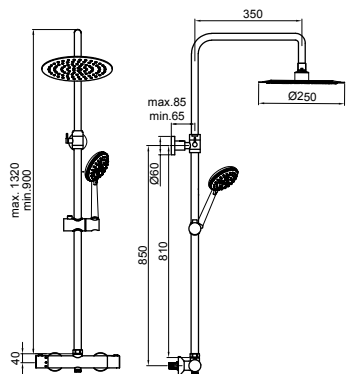

Termoline: Columna de ducha vista telescópica termostática de dos vías, rociador redondo INOX, flexo y mango de ducha autoclean. Sistema cool touch, sistema de tope de temperatura a 38°C y sistema de corte de seguridad.

Two outlets thermostatic slide bar shower mixer with cool touch system, safety stop at 38°C and supply fail protection.

Colonne de douche thermostatique télescopique à deux sorties avec pommeau rond en acier inoxydable et douchette. Système Cool Touch, limiteur de température à 38 °C et système d'arrêt de sécurité.

REFERENCIA PVP

44431 334,39 €

44431/N 487,33 €

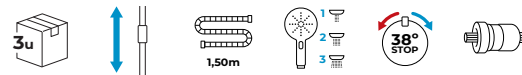

Colección INOA



Inoa destaca por su diseño fresco y exclusivo, pensado para quienes buscan una grifería con personalidad propia. Su sistema de apertura en frío y el ahorro de caudal reflejan el compromiso de Boet con la eficiencia y el confort. Disponible en cuatro elegantes acabados.

Inoa stands out for its fresh and exclusive design, created for those who seek a faucet with its own personality. Its cold-opening system and water-saving flow reflect Boet's commitment to efficiency and comfort. Available in four elegant finishes.

Inoa se distingue por son design frais et exclusif, conçu pour ceux qui recherchent une robinetterie avec une personnalité propre. Son système d'ouverture à froid et son économie de débit reflètent l'engagement de Boet envers l'efficacité et le confort. Disponible en quatre finitions élégantes.





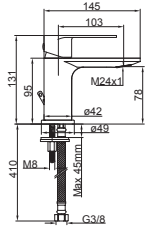

Monomando lavabo, apertura en frío y caudal de 5 l/m.





Single-lever basin mixer, cold start and flow rate 5 l/min.

Mitigeur monocommande lavabo avec C3, débit 5 l/min.



Adaptable a nivel BSC 5

REFERENCIA **PVP**

	39107	62,61 €
	39107/N	69,75 €
	39107/G	74,45 €
	39107/RG	77,80 €

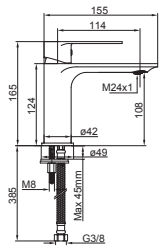

Monomando XL lavabo, apertura en frío y caudal de 5 l/m.





Single-lever XL basin mixer, cold start and flow rate 5 l/min.

Mitigeur monocommande lavabo XL avec C3, débit 5 l/min.



Adaptable a nivel BSC 5

REFERENCIA **PVP**

	39109	73,93 €
	39109/N	80,38 €
	39109/G	86,32 €
	39109/RG	91,40 €



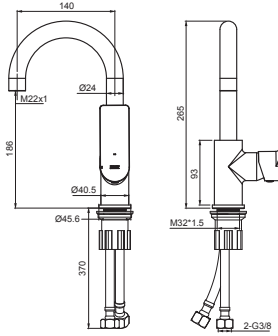

Monomando de caño alto para lavabo con apertura en frío y caudal de 5 l/m.

High spout single-lever basin mixer, cold start and flow rate 5 l/min.





Mitigeur monocommande lavabo à bec haut, avec C3 et débit 5 l/min.



Adaptable a nivel BSC 5

REFERENCIA

PVP

 39115	65,80 €
 39115/N	69,25 €
 39115/G	77,80 €
 39115/RG	82,25 €

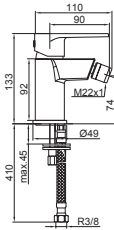

Monomando bidé con rótula giratoria. Caudal de 12,5 l/m.





Single-lever bidet mixer with swivel ball joint. Flow rate 12.5 l/min.

Mitigeur monocommande bidet avec rotule orientable. Débit 12,5 l/min.



REFERENCIA

PVP

 39227	55,72 €
 39227/N	62,31 €
 39227/G	68,80 €
 39227/RG	72,24 €

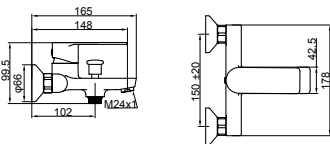











Monomando baño y ducha. Flexible 1,70 m INOX, inversor automático y mango de ducha ABS autoclean. Soporte orientable.
Single-lever bath and shower mixer. 1.70 m INOX flexible hose, automatic diverter and ABS autoclean hand shower. Adjustable wall bracket.

Mitigeur monocommande bain-douche. Flexible INOX 1,70 m, inverseur automatique et douchette ABS autoclean. Support orientable.

REFERENCIA

PVP

 39555	94,63 €	 8u	 35ø	 1,70m
 39555/N	125,06 €			
 39555/G	165,40 €			
 39555/RG	173,67 €			

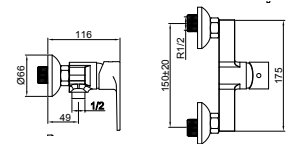

Monomando ducha con caudal 8 l/m. con flexible, soporte orientable y mango de ducha ABS autoclean. Caudal de 8 l/m.

Single-lever shower mixer, flow rate 8 l/min, with flexible hose, adjustable wall bracket and ABS autoclean hand shower.

Mitigeur monocommande douche, débit 8 l/min, avec flexible, support orientable et douchette ABS autoclean.

REFERENCIA

PVP

 39424	69,20 €	 8u	 35ø	 1,70m
 39424/N	95,99 €			
 39424/G	125,80 €			
 39424/RG	132,10 €			Adaptable a nivel BSC 5

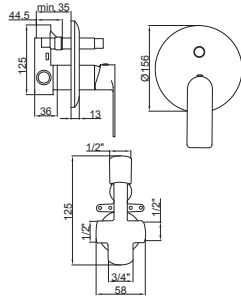

Monomando ducha empotrado con 2 vías. Caudal de baño 10,7 l/m, y ducha 10,3 l/m.

Built-in single-lever shower mixer with 2 outlets. Flow rate: bath 10.7 l/min, shower 10.3 l/min.

Mitigeur monocommande encastré douche à 2 voies. Débit : bain 10,7 l/min, douche 10,3 l/min.



REFERENCIA PVP

39556 | 160,63 €

REFERENCIA PVP

39556/N | 200,42 €

39556/G | 249,70 €

39556/RG | 258,70 €

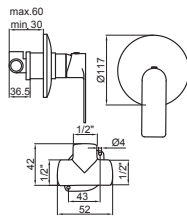

Monomando ducha empotrado de 1 vía. Caudal de 11,1 l/m.

Built-in single-lever shower mixer with 1 outlet. Flow rate 11.1 l/min.

Mitigeur monocommande encastré douche à 1 voie. Débit 11,1 l/min.



REFERENCIA PVP

39425 | 73,58 €

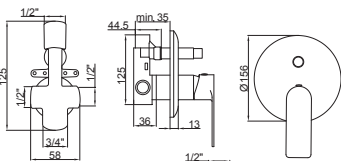

Pack monomando de ducha empotrada push de 2 vías con accesorios: brazo de pared, rociador INOX redondo, soporte integrado con toma de agua, flexo INOX 1,70 m y mango de ducha PVD anticalcáreo.

Built-in push single-lever shower mixer set, 2 outlets, with accessories: wall arm, round INOX shower head, integrated support with water inlet, 1.70 m INOX hose and PVD anti-limescale hand shower.

Pack mitigeur monocommande encastré douche push à 2 voies avec accessoires : bras mural, pomme de douche ronde INOX, support intégré avec arrivée d'eau, flexible INOX 1,70 m et douchette PVD anticalcaire.

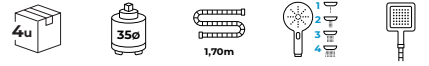

REFERENCIA PVP

Pack 39 Wall | 289,32 €

REFERENCIA PVP

Pack 39 Wall/N | 369,00 €

Pack 39 Wall/G | 415,75 €

Pack 39 Wall/RG | 426,93 €

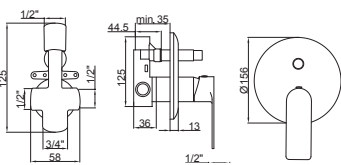

Pack monomando de ducha empotrada push de 2 vías con accesorios: brazo de techo, rociador INOX redondo, soporte integrado con toma de agua, flexo INOX 1,70 m y mango de ducha PVD anticalcáreo.

Built-in push single-lever shower mixer set, 2 outlets, with accessories: ceiling arm, round INOX shower head, integrated support with water inlet, 1.70 m INOX hose and PVD anti-limescale hand shower.

Pack mitigeur monocommande encastré douche push à 2 voies avec accessoires : bras de plafond, pomme de douche ronde INOX, support intégré avec arrivée d'eau, flexible INOX 1,70 m et douchette PVD anticalcaire.

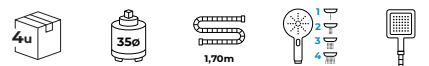

REFERENCIA PVP

Pack 39 top | 290,57 €

REFERENCIA PVP

Pack 39 top/N | 370,21 €

Pack 39 top/G | 419,56 €

Pack 39 top/RG | 430,45 €



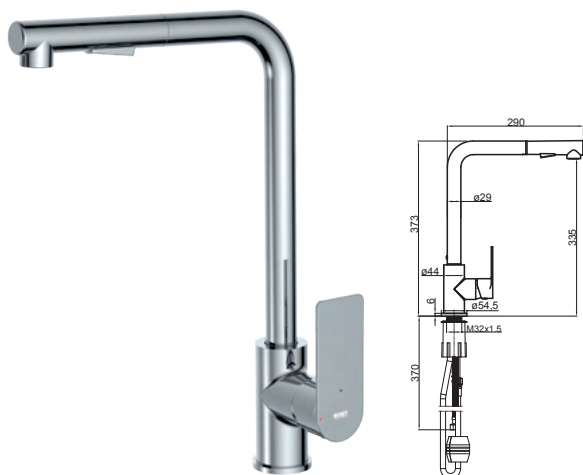

Monomando de cocina con ducha extraíble y apertura en frío. Caudal de 7,1 l/m.

Single-lever kitchen mixer with pull-out hand shower and cold start. Flow rate 7.1 l/min.

Mitigeur monocommande cuisine avec C3 et douchette extractible. Débit 7,1 l/min.

REFERENCIA PVP

39671 | 131,47 €

39671/N | 140,90 €

NOVEDAD

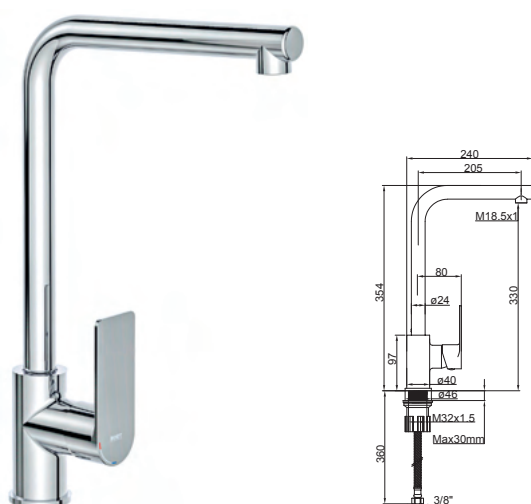

Monomando de cocina con apertura en frío y caño giratorio. Caudal de 5 l/m.

Single-lever kitchen mixer, cold start and swivel spout. Flow rate 5 l/min.

Mitigeur monocommande cuisine avec C3 et bec orientable. Débit 5 l/min.

REFERENCIA PVP

39657 | 72,35 €

39657/N | 82,74 €



Colección EROS



Diseñada para brindar bienestar y confort con un toque elegante. Disponible en acabados cromo y negro mate. incorpora apertura en frío y caudal ecológico de 5 l/m. Certificada por ACS.

Designed to provide well-being and comfort with an elegant touch. Available in chrome and matt black finishes. Features cold-start opening and an eco flow rate of 5 l/min. Certified by ACS.

Conçue pour offrir bien-être et confort avec une touche d'élégance. Disponible en finitions chrome et noir mat. Intègre ouverture sur l'eau froide (C3) et débit écologique de 5 l/min. Certifiée ACS.



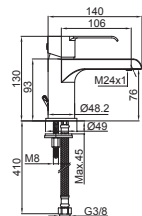

Monomando lavabo con apertura en frío y caudal de 5 l/m.

Single-lever basin mixer, with cold start and flow rate 5 l/m.

Mitigeur lavabo laiton avec C3 et débit 5 l/m.

REFERENCIA PVP

55107 | 67,26 €

55107/N | 72,87 €



Adaptable a nivel BSC 5

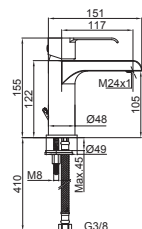

Monomando XL lavabo con apertura en frío y caudal de 5 l/m.

XL single-lever basin mixer, with cold start and flow rate 5 l/m.

Mitigeur XL pour lavabo laiton, avec C3 et débit 5 l/m.

REFERENCIA PVP

55109 | 76,54 €

55109/N | 80,93 €



Adaptable a nivel BSC 5

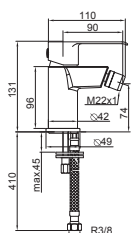

Monomando bidé con rótula giratoria.

Single-lever bidet mixer with directional aerator.

Mitigeur bidet laiton avec rotule orientable.

REFERENCIA PVP

55227 | 55,16 €

55227/N | 61,81 €

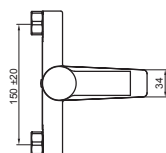
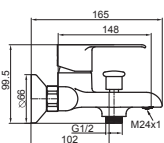

Monomando baño y ducha. Flexible, inversor automático y mango de ducha ABS autoclean. Soporte orientable.

Single-lever bath-shower mixer with flexible hose, automatic diverter and anti-limescale shower handset.

Mitigeur bain-douche laiton avec flexible, inverseur automatique et douchette anti calcaire. Support orientable.

REFERENCIA PVP

55555 | 92,05 €

55555/N | 126,23 €

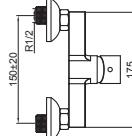
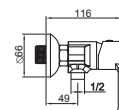

Monomando ducha con flexible, soporte orientable y mango de ducha ABS autoclean. Caudal de 8 l/m.

Single-lever automatic shower diverter and anti-limescale shower handset. Flow rate 8 l/m.

Mitigeur douche laiton avec flexible, douchette et support orientable. Débit 8 l/m.

REFERENCIA PVP

55424 | 68,66 €

55424/N | 95,52 €



Adaptable a nivel BSC 5

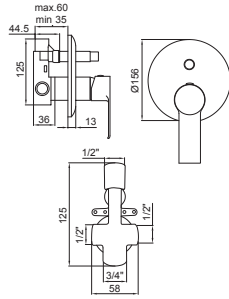

Monomando ducha empotrado con 2 vías. Caudal de 10,7 l/m.
 Wall mounted single-lever shower mixer with 2 ways. Flow rate 10,7 l/m.
 Mitigeur douche encastrable laiton avec 2 sorties. Débit 10,7 l/m.
 Box de raccordement.



REFERENCIA PVP

55556 | 162,32 €

REFERENCIA PVP

55556/N | 202,21 €

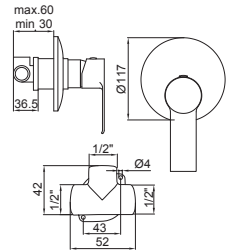

Monomando ducha empotrado de 1 vía.
 Wall mounted single-lever shower mixer with 1 outlet.
 Mitigeur douche laiton encastrable, 1 sortie. Box de raccordement.



REFERENCIA PVP

55425 | 74,84 €



Pack monomando de ducha empotrada push de 2 vías con accesorios: brazo de pared, rociador redondo, soporte integrado con toma de agua, flexo y maneral de ducha.
 Bathroom tap pack wall mounted Single-lever with 2 ways push: shower arm, round fixed overhead shower head, integrated shower outlet elbow and handset holder, shower hose and handset.
 Pack pour douche encastrée, avec 2 sorties push: bras mural, tête de pluie ronde, coude de raccordement mural avec support, flexible de douche et douchette.



REFERENCIA PVP

Pack 55 Wall | 291,00 €

REFERENCIA PVP

Pack 55 Wall/N | 370,79 €

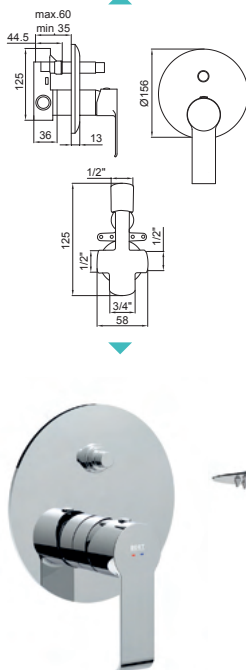

Pack monomando de ducha empotrada push de 2 vías con accesorios: brazo de techo, rociador redondo, soporte integrado con toma de agua, flexo y maneral de ducha.
 Bathroom tap pack top mounted Single-lever with 2 ways push: shower arm, round fixed overhead shower head, integrated shower outlet elbow and handset holder, shower hose and handset.
 Pack pour douche encastrée, avec 2 sorties push: bras de douche au toit, tête de pluie ronde, coude de raccordement mural avec support, flexible de douche et douchette. Box de raccordement.



REFERENCIA PVP

Pack 55 top | 292,25 €

REFERENCIA PVP

Pack 55 top/N | 372,00 €



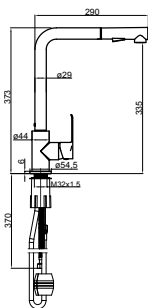

Monomando para fregadero con ducha extraíble y apertura en frío. Caudal de 7,1 l/m

Single-lever sink mixer with pull-out shower and Gentle Cold Start. Flow rate 7.1 l/min.

Mitigeur évier avec douchette extractible et ouverture sur l'eau froide C3. Débit 7,1 l/min.

REFERENCIA PVP

55671 | 131,47 €

55671/N | 142,56 €

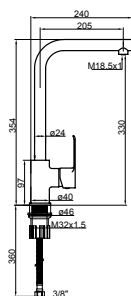

Monomando para fregadera con apertura en frío y caño giratorio. Caudal de 5 l/m

Single-lever sink mixer with Gentle Cold Start and swivel spout. Flow rate 5 l/min.

Mitigeur évier avec douchette extractible et ouverture sur l'eau froide C3. Débit 5 l/min.

REFERENCIA PVP

55657 | 71,85 €

55657/N | 82,74 €



Adaptable a nivel BSC 5

Colección NEOS



Diseño robusto de formas cúbicas moldeadas que imprimen carácter en todas las piezas de la colección. Certificado por ACS. Acabados en cromo.

Robust design with moulded cubic shapes that give character to every piece in the collection. ACS certified. Chrome finish.

Design robuste aux formes cubiques moulées qui confèrent du caractère à chaque pièce de la collection. Certifié ACS. Finition chrome.





Monomando lavabo.
Single-lever basin mixer.
Mitigeur lavabo.

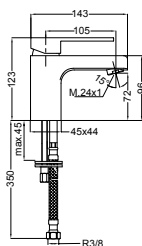

REFERENCIA PVP

94107 | 87,50 €



REFERENCIA PVP

94108 | 111,09 €



Monomando XL lavabo.
Single-lever basin mixer XL.
Mitigeur haut pour lavabo.

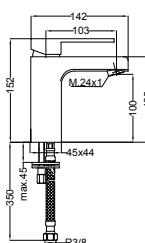

REFERENCIA PVP

94109 | 98,50 €



REFERENCIA PVP

94109V | 121,15 €



Monomando bidé con rótula giratoria.
Single-lever bidet mixer with directional aerator.
Mitigeur bidet avec rotule orientable.

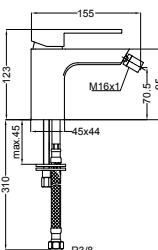

REFERENCIA PVP

94227 | 87,39 €



REFERENCIA PVP

94228 | 111,09 €



Monomando baño y ducha con inversor automático, soporte orientable, flexo y mango de ducha ABS autoclean.

Single-lever bath-shower mixer with support, flexible, automatic diverter and anti-limescale shower handset.

Mitigeur bain-douche. Flexible, inverseur automatique et douchette anti calcaire. Support orientable.



REFERENCIA PVP

94555 | 149,85 €



REFERENCIA PVP

94555/0 | 133,35 €

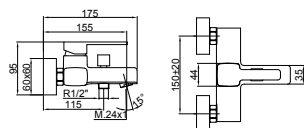



Monomando ducha con flexible, soporte orientable y mango de ducha ABS autoclean.

Single-lever shower mixer with diverter, support, flexible and anti-limescale shower handset.

Mitigeur douche avec flexible, douchette et support orientable.

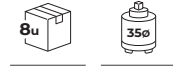

REFERENCIA PVP

94424 | 114,53 €



REFERENCIA PVP

94424/0 | 97,95 €

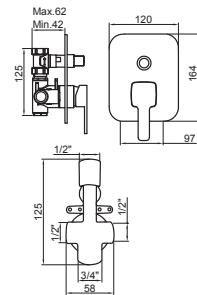

Monomando ducha empotrado con 2 vías.

Wall mounted single-lever shower mixer with 2 outlets.

Mitigeur douche encastrable avec 2 sorties.



REFERENCIA PVP

94556 | 247,80 €

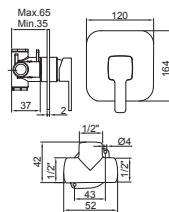

Monomando ducha empotrado con 1 vía.

Wall mounted single-lever shower mixer with 1 outlet.

Mitigeur douche encastrable, 1 sortie.



REFERENCIA PVP

94425 | 176,53 €



Monomando fregadero con caño giratorio.

Single-lever kitchen mixer with swivel spout.

Mitigeur évier avec bec pivotant.



REFERENCIA PVP

94658 | 134,63 €

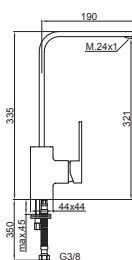



REFERENCIA PVP

● Pack 94 Wall | 356,47 €

Pack monomando ducha empotrada push con 2 vías con accesorios: brazo de pared, rociador cuadrado, soporte con toma de agua, flexo y mango de ducha ABS autoclean.

Bathroom tap pack wall mounted Single-lever with 2 ways push: shower arm, squared fixed overhead shower head, shower outlet elbow and handset holder, shower hose and handset.

Pack pour douche encastrée, avec 2 sorties push: bras mural, tête de pluie carrée, coude de raccordement mural avec support, flexible de douche et douchette.

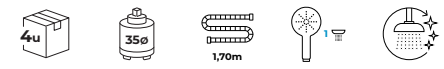

REFERENCIA PVP

● Pack 94 Top | 357,68 €

Pack monomando ducha empotrada push con 2 vías con accesorios: brazo de techo, rociador cuadrado, soporte con toma de agua, flexo y mango de ducha ABS autoclean.

Bathroom tap pack top mounted Single-lever with 2 ways push: shower top, squared fixed overhead shower head, shower outlet elbow and handset holder, shower hose and handset.

Pack pour douche encastrée, avec 2 sorties push: bras de douche au plafond, tête de pluie carrée, coude de raccordement mural avec support, flexible de douche et douchette.

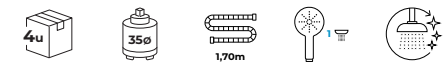

Colección ICE



Diseño elegante con cuerpo cilíndrico combinado con planos rectos en el caño, imponiendo personalidad a tu hogar. Equipada con apertura en frío y doble apertura, con caudal mínimo de 5,5 l/m.

Elegant design with a cylindrical body combined with flat surfaces on the spout, adding personality to your home. Equipped with cold-start opening and dual-opening system, with a minimum flow rate of 5.5 l/min.

Design élégant avec un corps cylindrique combiné à des surfaces planes sur le bec, apportant de la personnalité à votre maison. Équipée d'une ouverture sur l'eau froide (C3) et double ouverture (C2), avec un débit minimum de 5,5 l/min.



Colección ASTON

NOVEDAD



Aston se define por su silueta moderna, de líneas firmes y proporciones equilibradas que transmiten distinción y estilo. Dotada de apertura en frío y tecnología de ahorro de caudal que permite reducir el consumo de agua sin renunciar al confort. Disponible en una amplia gama de acabados.

Aston is defined by its modern silhouette, with clean lines and balanced proportions that convey distinction and style. Equipped with cold start and flow-saving technology, it helps reduce water consumption without compromising comfort. Available in a wide range of finishes.

Aston se distingue par sa silhouette moderne, aux lignes épurées et aux proportions équilibrées qui transmettent distinction et style. Dotée d'un système d'ouverture à froid et d'une technologie d'économie de débit, elle permet de réduire la consommation d'eau sans renoncer au confort. Disponible dans une large gamme de finitions.



NOVEDAD ASTON

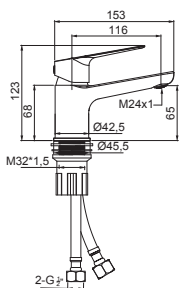

Monomando lavabo, apertura en frío y caudal de 5 l/m.





Single lever basin mixer, cold start, 5 l/min flow rate.

Mitigeur lavabo, ouverture à froid, débit de 5 l/min.



Adaptable a nivel BSC 5

REFERENCIA PVP

	56107	51,45 €
	56107/N	61,80 €
	56107/G	74,90 €
	56107/RG	74,90 €

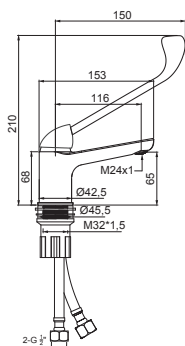

Monomando lavabo con maneta gerontológica y apertura en frío. Caudal de 5 l/m.

Mitigeur de lavabo, avec manette gérontologique et ouverture sur l'eau froide C3. Débit de 5 l/min.

Single-lever basin mixer, with elbow-action handle and gentle cold start. Flow rate of 5 l/min.



Adaptable a nivel BSC 5

REFERENCIA PVP

	56107/GER	63,45 €
	56107/N/GER	75,80 €

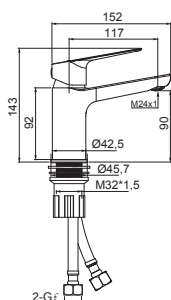

Monomando XL lavabo, apertura en frío y caudal de 5 l/m.





XL single lever basin mixer, cold start, 5 l/min flow rate.

Mitigeur lavabo XL, ouverture à froid, débit de 5 l/min.



Adaptable a nivel BSC 5

REFERENCIA PVP

	56109	61,25 €
	56109/N	69,80 €
	56109/G	84,25 €
	56109/RG	84,25 €

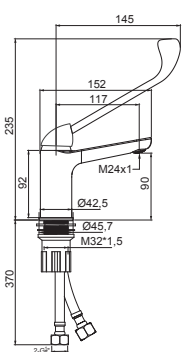

Monomando lavabo con maneta gerontológica y apertura en frío. Caudal de 5 l/m.

Mitigeur de lavabo, avec manette gérontologique et ouverture sur l'eau froide C3. Débit de 5 l/min.

Single-lever basin mixer, with elbow-action handle and gentle cold start. Flow rate of 5 l/min.



Adaptable a nivel BSC 5

REFERENCIA PVP

	56109/GER	73,25 €
	56109/N/GER	83,80 €

Producto Relacionado



Ref. 4025

Desagüe pulsador rápido de latón clic-clac con rosca de 1" 1/4.

Brass clic-clac pop-up waste with 1" 1/4 thread.

Bonde laiton clic-clac, 1" 1/4.



Monomando XXL lavabo, apertura en frío y caudal de 5 l/m.

XXL single lever basin mixer, cold start, 5 l/min flow rate.

Mitigeur lavabo XXL, ouverture à froid, débit de 5 l/min.

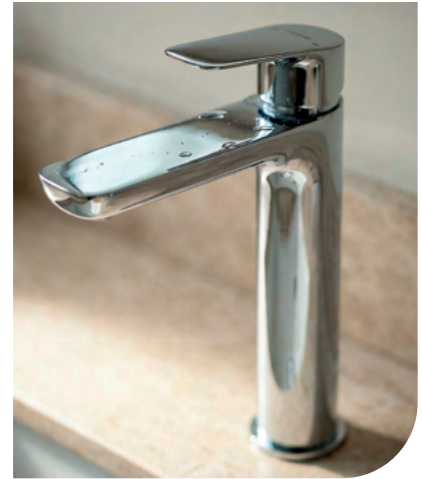
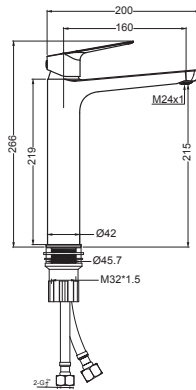

REFERENCIA **PVP**

	56111	101,80 €
	56111/N	111,42 €
	56111/G	134,50 €
	56111/RG	134,50 €



Monomando lavabo de caño alto, apertura en frío y caudal de 5 l/m.

High spout single lever basin mixer, cold start, 5 l/min flow rate.

Mitigeur lavabo à bec haut, couverture à froid, débit de 5 l/min.

REFERENCIA **PVP**

	56115	54,21 €
	56115/N	62,25 €
	56115/G	79,40 €
	56115/RG	79,40 €

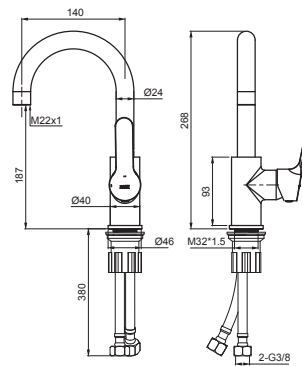
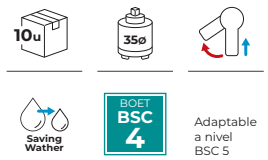

Monomando bidé con rótula giratoria.

Single lever bidet mixer with swivel joint.

Mitigeur bidet avec rotule orientable.

REFERENCIA **PVP**

	56227	48,30 €
	56227/N	59,48 €
	56227/G	71,25 €
	56227/RG	71,25 €

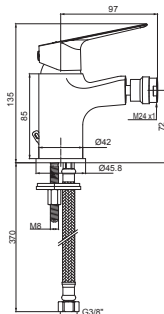
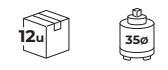

NOVEDAD ASTON





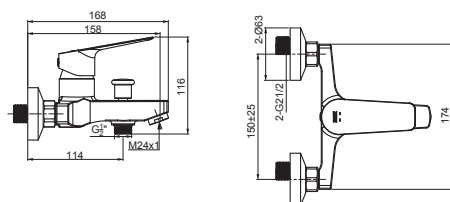
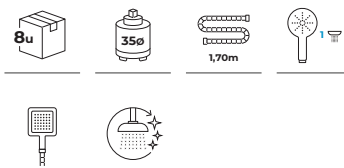

Monomando baño y ducha. Flexible, inversor automático y mango de ducha ABS autoclean. Soporte orientable.

Single lever bath and shower mixer. With flexible hose, automatic diverter and ABS autoclean hand shower. Adjustable wall bracket.

Mitigeur bain-douche. Flexible, inverseur automatique et douchette ABS autoclean. Support orientable.



REFERENCIA PVP

 56555	77,90 €
 56555/N	110,40 €
 56555/G	129,90 €
 56555/RG	129,90 €





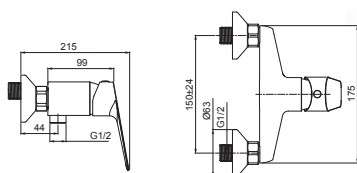
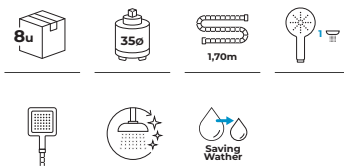

Monomando ducha con flexible, soporte orientable y mango de ducha ABS autoclean. Caudal de 12 l/m.

Single lever shower mixer with flexible hose, adjustable wall bracket and ABS autoclean hand shower. 12 l/min flow rate.

Mitigeur douche avec flexible, support orientable et douchette ABS autoclean. Débit de 12 l/min.



REFERENCIA PVP

 56424	57,90 €
 56424/N	83,90 €
 56424/G	98,40 €
 56424/RG	98,40 €



Monomando ducha empotrado de 1 vía.
Concealed single lever shower mixer, 1 outlet.
Mitigeur encastré douche 1 voie.

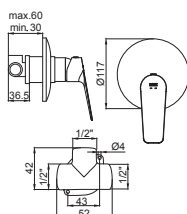

REFERENCIA PVP

 56425	70,84 €
---	---------





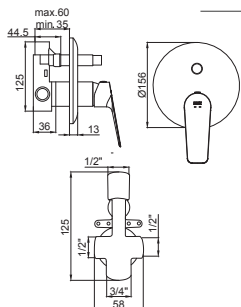

Monomando ducha empotrado con 2 vías.
Caudal de 12 l/m.

*Concealed single lever shower mixer, 2 outlets.
12 l/min flow rate.*

*Mitigeur encastré douche 2 voies. Débit de
12 l/min.*



REFERENCIA **PVP**

	56556	144,39 €
	56556/N	180,88 €
	56556/G	198,45 €
	56556/RG	198,45 €





Pack monomando ducha empotrado 2 vías con brazo de pared, rociador INOX redondo ø 25 cm, soporte con toma de agua, flexo y mango de ducha ABS autoclean.

Pack wall mounted shower single lever 2 ways with accessories: wall arm, round shower head, support with water connection, hose and shower handle.

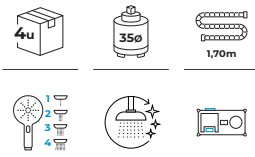
Pack mitigeur douche encastrable 2 sorties, avec accessoires: bras mural, pomme de douche ronde, support avec raccord d'eau, flexible et douchette.



REFERENCIA **PVP**

	Pack 56 Wall	288,25 €
	Pack 56 Wall/N	316,45 €
	Pack 56 Wall/G	414,50 €
	Pack 56 Wall/RG	414,50 €



Pack monomando ducha empotrado 2 vías con brazo de techo, rociador INOX redondo ø 25 cm, soporte con toma de agua, flexo y mango de ducha ABS autoclean.

Pack wall mounted shower single lever 2 ways with accessories: top arm, round shower head, support with water connection, hose and shower handle.

Pack mitigeur douche encastrable 2 sorties, avec accessoires: bras de douche au toit, pomme de douche ronde, support avec raccord d'eau, flexible et douchette.

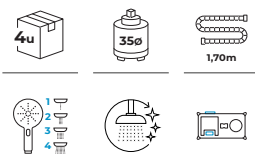

REFERENCIA **PVP**

	Pack 56 Top	289,50 €
	Pack 56 Top/N	341,75 €
	Pack 56 Top/G	415,75 €
	Pack 56 Top/RG	426,93 €



NOVEDAD ASTON

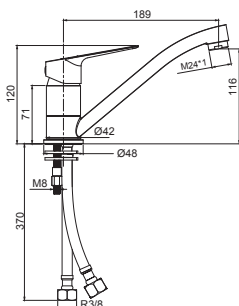

Monomando para fregadera con apertura en frío y caño horizontal giratorio.

Single lever kitchen mixer, cold start, with horizontal swivel spout.

Mitigeur évier avec ouverture à froid et bec horizontal orientable.

REFERENCIA	PVP
------------	-----

 56660	41,25 €
---	---------



Monomando para fregadera con apertura en frío y caño giratorio. Caudal de 5 l/m.

Single lever kitchen mixer, cold start, with swivel spout. 5 l/min flow rate.

Mitigeur évier, ouverture à froid, bec orientable. Débit de 5 l/min.

REFERENCIA	PVP
------------	-----

 56657	57,06 €
---	---------

 56657/N	63,80 €
---	---------

 56657/G	84,22 €
---	---------



Adaptable a nivel BSC 5

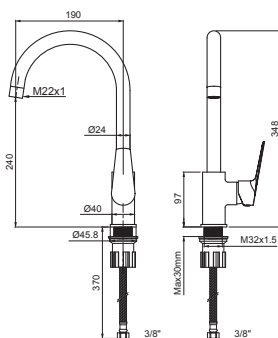

Colección DUNA

NOVEDAD



Duna se distingue por su diseño fresco, elegante y empático, pensado para quienes buscan equilibrio y armonía. Equipada con apertura en frío para evitar el encendido innecesario del calentador y un sistema de ahorro de caudal que reduce el consumo de agua sin perder confort. Disponible en una amplia variedad de acabados.

Duna stands out for its fresh, elegant, and empathetic design, created for those seeking balance and harmony. Equipped with cold-start technology to prevent unnecessary activation of the water heater and a flow-saving system that reduces water consumption without sacrificing comfort. Available in a wide range of finishes.

Duna se distingue par son design frais, élégant et empathique, conçu pour ceux qui recherchent équilibre et harmonie. Équipée d'une ouverture à froid évitant l'allumage inutile du chauffe-eau et d'un système d'économie de débit réduisant la consommation d'eau sans compromettre le confort. Disponible dans une large gamme de finitions.



NOVEDAD DUNA

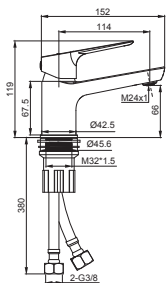

Monomando lavabo, apertura en frío y caudal de 5 l/m.

Single lever basin mixer, cold start, 5 l/min flow rate.

Mitigeur lavabo, ouverture à froid, débit de 5 l/min.



Adaptable a nivel BSC 5

REFERENCIA	PVP
57107	51,45 €
57107/N	61,80 €
57107/G	74,90 €
57107/RG	74,90 €

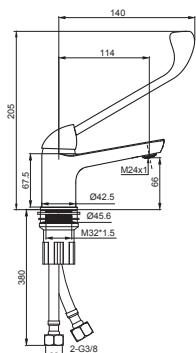

Monomando lavabo con maneta gerontológica y apertura en frío. Caudal de 5 l/m.

Mitigeur de lavabo, avec manette gérontologique et ouverture sur l'eau froide C3. Débit de 5 l/min.

Single-lever basin mixer, with elbow-action handle and gentle cold start. Flow rate of 5 l/min.



Adaptable a nivel BSC 5

REFERENCIA	PVP
57107/GER	63,45 €
57107/N/GER	75,80 €

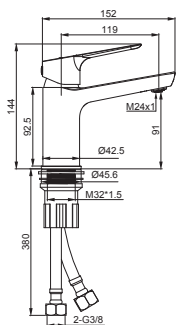

Monomando XL lavabo, apertura en frío y caudal de 5 l/m.

XL single lever basin mixer, cold start, 5 l/min flow rate.

Mitigeur lavabo XL, ouverture à froid, débit de 5 l/min.



Adaptable a nivel BSC 5

REFERENCIA	PVP
57109	61,25 €
57109/N	69,80 €
57109/G	84,25 €
57109/RG	84,25 €

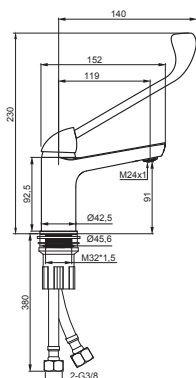

Monomando lavabo con maneta gerontológica y apertura en frío. Caudal de 5 l/m.

Mitigeur de lavabo, avec manette gérontologique et ouverture sur l'eau froide C3. Débit de 5 l/min.

Single-lever basin mixer, with elbow-action handle and gentle cold start. Flow rate of 5 l/min.



Adaptable a nivel BSC 5

REFERENCIA	PVP
57109/GER	73,25 €
57109/N/GER	83,80 €

Producto
Relacionado



Ref. 4025

Desagüe pulsador rápido de latón clic-clac con rosca de 1" 1/4.

Brass clic-clac pop-up waste with 1" 1/4 thread.

Bonde laiton clic-clac, 1" 1/4.



Monomando XXL lavabo, apertura en frío y caudal de 5 l/m.
 XXL single lever basin mixer, cold start, 5 l/min flow rate.
 Mitigeur lavabo XXL, ouverture à froid, débit de 5 l/min.

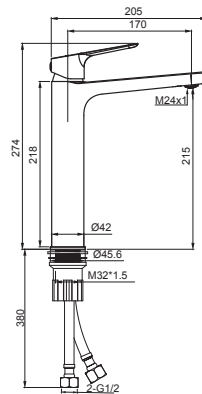

REFERENCIA	PVP
57111	101,80 €
57111/N	111,42 €
57111/G	134,50 €
57111/RG	134,50 €



Monomando de caño alto para lavabo con caudal de 5 l/m.
 High spout single lever basin mixer, 5 l/min flow rate.
 Mitigeur lavabo à bec haut, débit de 5 l/min.

REFERENCIA	PVP
57115	54,21 €
57115/N	62,25 €
57115/G	79,40 €
57115/RG	79,40 €

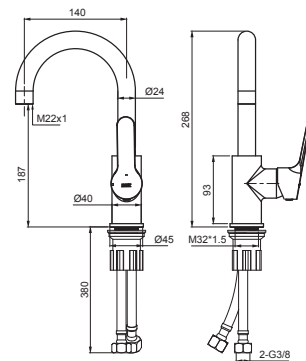
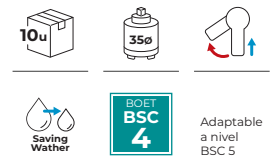

Monomando bidé con rótula giratoria.
 Single lever bidet mixer with swivel joint.
 Mitigeur bidet avec rotule orientable.

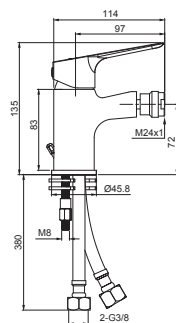
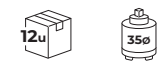

REFERENCIA	PVP
57227	48,30 €
57227/N	59,48 €
57227/G	71,25 €
57227/RG	71,25 €



Monomando ducha empotrado con 2 vías.
Caudal de 12 l/m.

*Concealed single lever shower mixer, 2 outlets.
12 l/min flow rate.*

*Mitigeur encastré douche 2 voies.
Débit de 12 l/min.*

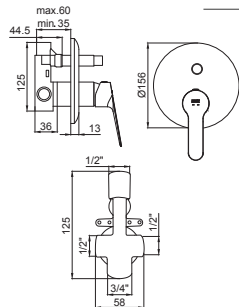

Vídeo de instalación
Installation video
Vidéo d'installation

REFERENCIA **PVP**

	57556	144,39 €
	57556/N	180,88 €
	57556/G	198,45 €
	57556/RG	198,45 €



Pack monomando ducha empotrado 2 vías con brazo de pared, rociador INOX redondo ø 25 cm, soporte con toma de agua, flexo y mango de ducha ABS autoclean.

Pack wall mounted shower single lever 2 ways with accessories: wall arm, round shower head, support with water connection, hose and shower handle.

Pack mitigeur douche encastrable 2 sorties, avec accessoires: bras mural, pomme de douche ronde, support avec raccord d'eau, flexible et douchette.



Vídeo de instalación
Installation video
Vidéo d'installation

REFERENCIA **PVP**

	Pack 57 Wall	288,25 €
	Pack 57 Wall/N	316,45 €
	Pack 57 Wall/G	414,50 €
	Pack 57 Wall/RG	414,50 €



Pack monomando ducha empotrado 2 vías con brazo de techo, rociador INOX redondo ø 25 cm, soporte con toma de agua, flexo y mango de ducha ABS autoclean.

Pack wall mounted shower single lever 2 ways with accessories: top arm, round shower head, support with water connection, hose and shower handle.

Pack mitigeur douche encastrable 2 sorties, avec accessoires: bras de douche au toit, pomme de douche ronde, support avec raccord d'eau, flexible et douchette.



Vídeo de instalación
Installation video
Vidéo d'installation

REFERENCIA **PVP**

	Pack 57 Top	289,50 €
	Pack 57 Top/N	341,75 €
	Pack 57 Top/G	415,75 €
	Pack 57 Top/RG	426,93 €

NOVEDAD DUNA

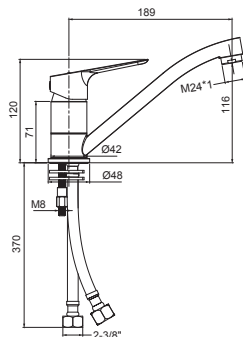

Monomando para fregadera con apertura en frío y caño horizontal giratorio.

Single lever kitchen mixer, cold start, with horizontal swivel spout.

Mitigeur évier avec ouverture à froid et bec horizontal orientable.

REFERENCIA	PVP
------------	-----

 57660	41,25 €
---	---------



Monomando para fregadera con apertura en frío y caño giratorio. Caudal de 5 l/m.

Single lever kitchen mixer, cold start, with swivel spout. 5 l/min flow rate.

Mitigeur évier, ouverture à froid, bec orientable. Débit de 5 l/min.

REFERENCIA	PVP
------------	-----

 57657	57,06 €
---	---------

 57657/N	63,80 €
---	---------

 57657/G	84,22 €
---	---------

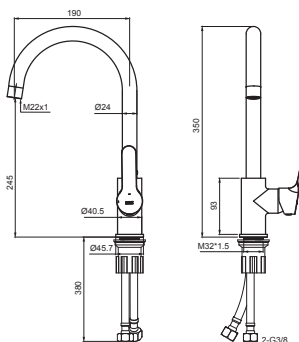

Colección LUCA



Colección de estética robusta con contornos delicados y suaves, convence por su atractiva personalidad. Acabados en negro y cromo. Caudal ecológico.

Collection with a robust aesthetic and smooth, delicate contours, distinguished by its appealing personality. Available in black and chrome finishes. Eco flow rate.

Collection à l'esthétique robuste aux contours doux et délicats, séduisant par sa personnalité attrayante. Disponible en finitions noir et chrome. Débit écologique.





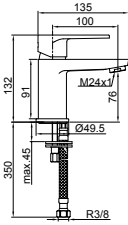



Monomando lavabo con caudal de 5 l/m.
Single-lever basin mixer with flow rate 5 l/m.
Mitigeur lavabo laiton avec débit 5 l/m.



Adaptable a nivel BSC 5

REFERENCIA PVP

	14107	48,30 €
	14107/N	59,48 €



REFERENCIA PVP

	14108	69,43 €
---	-------	---------

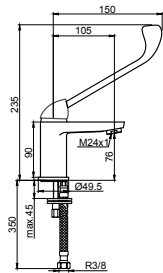

Monomando lavabo con maneta gerontológica. Caudal de 5 l/m.
Mitigeur de lavabo, avec manette gérontologique. Débit de 5 l/min.
Single-lever basin mixer, with elbow-action handle. Flow rate of 5 l/min.



Adaptable a nivel BSC 5

REFERENCIA PVP

	14107/GER	60,30 €
	14107/N/GER	73,48 €

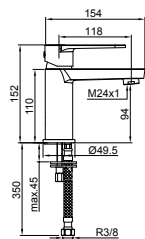



Monomando lavabo XL con caudal de 5 l/m.
Extended height single-lever basin mixer with flow rate 5 l/m.
Mitigeur lavabo laiton haut avec débit 5 l/m.



Adaptable a nivel BSC 5

REFERENCIA PVP

	14109	60,25 €
	14109/N	66,29 €

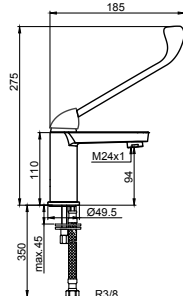



Monomando lavabo con maneta gerontológica. Caudal de 5 l/m.
Mitigeur de lavabo, avec manette gérontologique. Débit de 5 l/min.
Single-lever basin mixer, with elbow-action handle. Flow rate of 5 l/min.



Adaptable a nivel BSC 5

REFERENCIA PVP

	14109/GER	72,25 €
	14109/N/GER	80,29 €

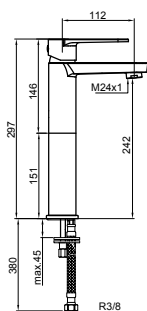

Monomando lavabo XXL con caudal de 5 l/m.
 XXL single-lever basin mixer with flow rate 5 l/m.
 Mitigeur lavabo laiton XXL avec débit 5 l/m.



Adaptable a nivel BSC 5

REFERENCIA PVP

14111 | 99,91 €

14111/N | 107,42 €

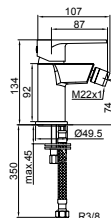

Monomando bidé con rótula giratoria. Caudal de 5 l/m.

Single-lever bidet mixer, directional aerator. Flow rate 5 l/m.

Mitigeur bidet, rotule orientable, avec débit 5 l/m.



Adaptable a nivel BSC 5

REFERENCIA PVP

14227 | 48,30 €

14227/N | 59,48 €



REFERENCIA PVP

14228 | 69,43 €

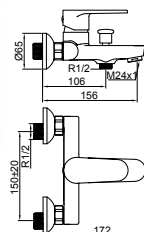

Monomando baño-ducha con inversor automático, soporte orientable, flexo y mango de ducha ABS autoclean.

Single-lever automatic bath-shower diverter with flexible, anti-limescale shower handset.

Mitigeur bain-douche. Flexible, inverseur automatique, douchette anti calcaire. Support orientable.



REFERENCIA PVP

14555 | 85,07 €

14555/N | 115,35 €



REFERENCIA PVP

14555/0 | 75,23 €

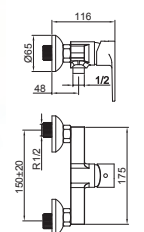

Monomando ducha con flexible, soporte orientable y mango de ducha ABS autoclean.

Single-lever automatic shower diverter, anti-limescale shower handset. Flow rate, 8,2 l/m.

Mitigeur douche, flexible, douchette et support orientable. Débit 8,2 l/m.



Adaptable a nivel BSC 5

REFERENCIA PVP

14424 | 65,99 €

14424/N | 88,80 €



REFERENCIA PVP

14424/0 | 56,15 €



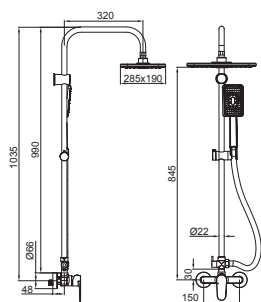

Columna de ducha fija con monomando, inversor de 2 vías, rociador rectangular 285 x 190 mm ABS autoclean y mango ducha ABS autoclean.

Single-lever round fixed bar shower mixer kit, diverter, hose, ABS auto clean hand shower and ABS auto clean squared overhead.

Barre de douche, avec mitigeur, inverseur 2 sorties, pomme de douche carrée ABS autoclean et douchette ABS autoclean.

REFERENCIA PVP



14430

213,34 €

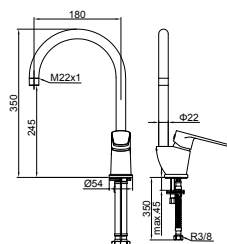
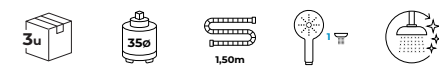

Monomando fregadero con caño giratorio y caudal de 5 l/m.

Single-lever kitchen mixer with swivel spout, flow rate 5 l/m.

Mitigeur évier avec bec pivotant. Débit 5 l/m.

REFERENCIA PVP



14657

63,05 €



14657/N

81,27 €



Colección EBRO



La colección Ebro combina diseño moderno y conciencia ecológica en perfecta armonía. Con un caudal ecológico inferior a 5 litros por minuto, esta línea de grifería garantiza un consumo eficiente de agua sin renunciar al confort ni a la estética.

The Ebro collection combines modern design and ecological awareness in perfect harmony. With an eco-friendly flow rate of less than 5 liters per minute, this range of faucets ensures efficient water consumption without sacrificing comfort or aesthetics.

La collection Ebro allie design moderne et conscience écologique en parfaite harmonie. Avec un débit écologique inférieur à 5 litres par minute, cette gamme de robinetterie garantit une consommation d'eau efficace sans renoncer au confort ni à l'esthétique.



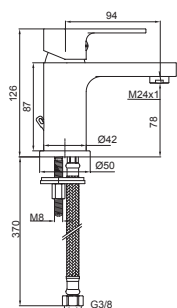

Monomando lavabo, con caudal de 5 l/m.

Single lever basin mixer, 5 l/min flow rate.

Mitigeur lavabo, débit de 5 l/min.



Adaptable a nivel BSC 5

REFERENCIA	PVP
38107	43,37 €
38107/N	50,95 €



Monomando lavabo caño giratorio con caudal de 5 l/m.

Single lever basin mixer with swivel spout, 5 l/min flow rate.

Mitigeur lavabo avec bec orientable, débit de 5 l/min.

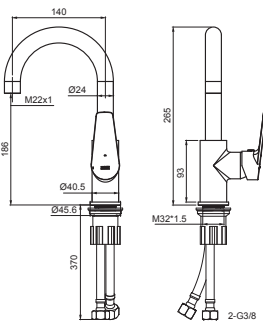

REFERENCIA	PVP
38115	53,95 €
38115/N	61,90 €



Adaptable a nivel BSC 5

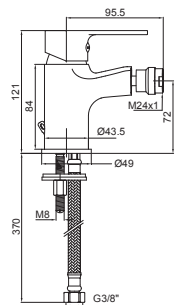

Monomando bidé con rótula giratoria.

Single lever bidet mixer with adjustable ball joint.

Mitigeur bidet avec rotule orientable.



REFERENCIA	PVP
38227	39,68 €
38227/N	47,85 €



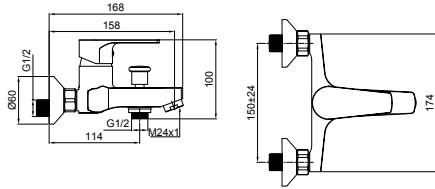

Monomando baño-ducha. Inversor automático, soporte orientable, flexo y mango de ducha ABS autoclean.

Single lever bath-shower mixer. Automatic diverter, adjustable wall bracket, ABS autoclean hand shower and flexible hose.

Mitigeur bain-douche. Inverseur automatique, support orientable, douchette ABS autoclean et flexible.

REFERENCIA **PVP**

38555 | **74,84 €**

38555/N | **107,40 €**

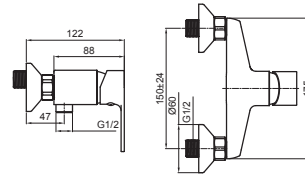
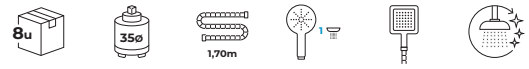

Monomando ducha, con flexible, soporte orientable y mango de ducha ABS autoclean. Caudal 8 l/m.

Single lever shower mixer, with flexible hose, adjustable wall bracket and ABS autoclean hand shower. 8 l/min flow rate.

Mitigeur douche, avec flexible, support orientable et douchette ABS autoclean. Débit de 8 l/min.

REFERENCIA **PVP**

38424 | **55,91 €**

38424/N | **86,88 €**

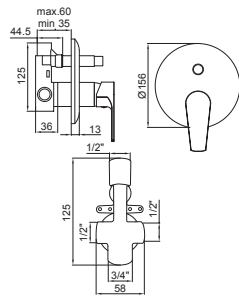
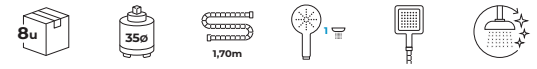

Monomando ducha empotrado con 2 vías.

Concealed single lever shower mixer with 2 outlets.

Mitigeur de douche encastré à 2 voies.

REFERENCIA **PVP**

38556 | **144,39 €**

38556/N | **180,88 €**

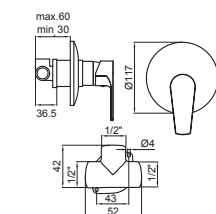

Monomando ducha empotrado de 1 vía.

Concealed single lever shower mixer with 1 outlet.

Mitigeur de douche encastré à 1 voie.

REFERENCIA **PVP**

38425 | **67,30 €**



EBRO

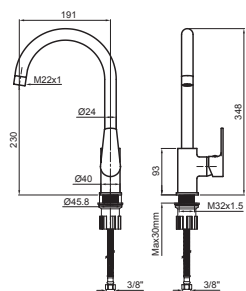

Monomando para fregadero con caño giratorio. Caudal de 5 l/m.

Single lever sink mixer with swivel spout. 5 l/min flow rate.

Mitigeur évier avec bec orientable. Débit de 5 l/min.

REFERENCIA PVP

38657 | 57,06 €

38657/N | 63,80 €



Adaptable a nivel BSC 5

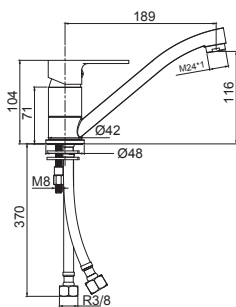

Monomando para fregadera con caño horizontal giratorio.

Single lever kitchen mixer with horizontal swivel spout.

Mitigeur cuisine avec bec horizontal orientable.

REFERENCIA PVP

38660 | 41,25 €



Colección TRIANON



Grifería de líneas esbeltas y orgullosas que se adapta a cualquier tipo de vivienda gracias a sus formas modernas, su ergonomía y funcionalidad. Certificada por Aenor. Acabados en cromo.

Slim and elegant tapware that adapts to any type of home due to its modern shapes, ergonomics, and functionality. AENOR certified. Chrome finish.

Robinetterie fine et élégante, qui s'adapte à tout type d'habitation grâce à ses formes modernes, son ergonomie et sa fonctionnalité. Certifiée AENOR. Finition chrome.



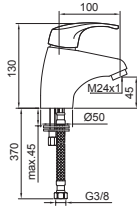

Monomando lavabo.
Single-lever basin mixer.
Mitigeur lavabo.



REFERENCIA PVP
80107MX | 71,46 €



REFERENCIA PVP
80108MX | 94,67 €

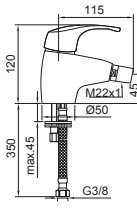

Monomando bidé con
rótula giratoria.
Single-lever bidet mixer
with directional aerator.
Mitigeur bidet, rotule
orientable.



REFERENCIA PVP
80227MX | 71,46 €



REFERENCIA PVP
80228MX | 94,67 €



Monomando baño-ducha con
inversor automático, soporte
orientable, flexo y mango de
ducha ABS autoclean.
Single-lever bath-shower mixer with
diverter, shower hose, orientable
support and anti-limescale shower
handset.

Mitigeur bain-douche avec flexible,
inverseur automatique et douchette
anti calcaire. Support orientable.

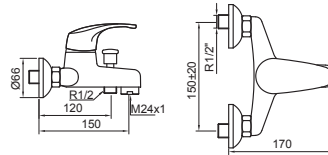
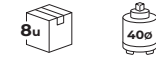

REFERENCIA PVP
80555MX | 109,81 €



REFERENCIA PVP
80555MX/0 | 94,18 €



Monomando ducha con flexible,
soporte orientable y mango de
ducha ABS autoclean.
Single-lever shower mixer with
diverter, shower hose, orientable
support and anti-limescale shower
handset.

Mitigeur douche avec flexible,
douchette et support orientable.

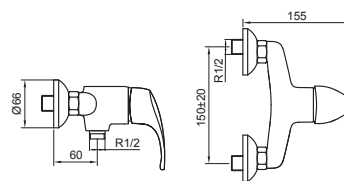

REFERENCIA PVP
80424MX | 83,69 €



REFERENCIA PVP
80424MX/0 | 69,23 €



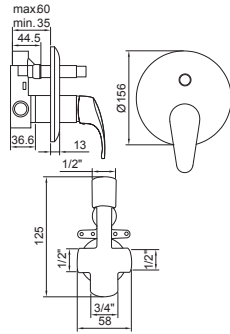

Monomando ducha empotrado con 2 vías. Sin complementos.
 Wall mounted single-lever shower mixer with 2 ways. Without accessories.
 Mitigeur douche encastrable avec 2 sorties. Sans accessoires.



REFERENCIA PVP

80556MX | 170,18 €

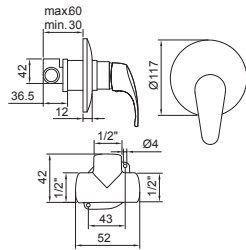

Monomando ducha empotrado de 1 vía. Sin complementos.
 Wall mounted single-lever shower mixer with 1 outlet. Without accessories.
 Mitigeur douche encastrable, 1 sortie. Sans accessoires.



REFERENCIA PVP

80425MX | 65,28 €



Columna de ducha vista telescópica con monomando, selector de función, rociador, flexo y mango de ducha autoclean.
 Shower mixer set, height adjustable mixer shower system with single-lever and selector, round ABS overhead rainfall and high pressure 2 jets ABS handled shower.
 Colonne de douche extensible, avec mitigeur et sélecteur, pomme de douche et douchette anti calcaires.

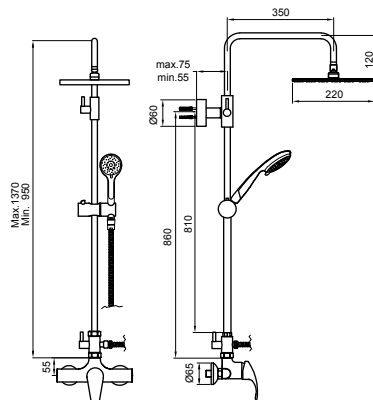
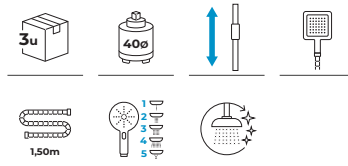

REFERENCIA PVP

80430MX | 367,00 €





Monomando fregadero con caño fundido giratorio.
Single-lever kitchen mixer with swivel spout.
Mitigeur évier avec bec pivotant.

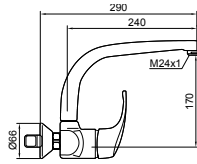
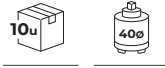

REFERENCIA PVP

80652MX | 144,33 €



Monomando fregadero con caño fundido giratorio.
Single-lever kitchen mixer with swivel spout.
Mitigeur évier avec bec pivotant.

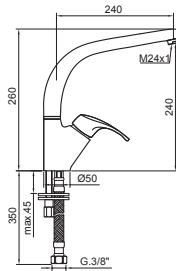

REFERENCIA PVP

80658MX | 141,00 €



Monomando fregadero con caño giratorio extraíble.
Single-lever kitchen mixer with swivel spout and pull-out spray.
Mitigeur évier avec bec pivotant et douchette extractible.

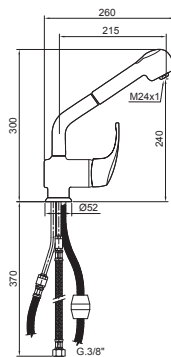
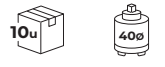

REFERENCIA PVP

80670MX | 150,14 €

Colección BACK



Diseño sóbrio con líneas rectas y definidas inspiradoras de energía y optimismo. Acabados en cromo.

Sober design with clean, defined lines that inspire energy and optimism. Chrome finish.

Design sobre aux lignes droites et définies, inspirant énergie et optimisme. Finition chromée.



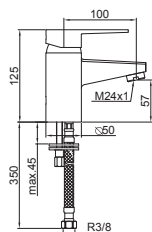

Monomando lavabo.
Single-lever basin mixer.
Mitigeur lavabo.



REFERENCIA PVP
21107 | 68,53 €



REFERENCIA PVP
21108 | 93,61 €

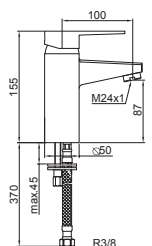

Monomando lavabo XL.
Extended height single-lever basin mixer.
Mitigeur lavabo XL.



REFERENCIA PVP
21109 | 79,52 €



REFERENCIA PVP
21109/V | 103,84 €

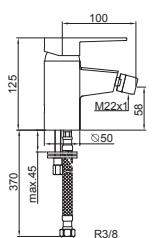

Monomando bidé con rótula giratoria.
Single-lever bidet mixer with directional aerator.
Mitigeur bidet, rotule orientable.



REFERENCIA PVP
21227 | 70,03 €



REFERENCIA PVP
21228 | 95,13 €



Monomando baño-ducha con Inversor automático, soporte orientable, flexo y mango de ducha ABS autoclean.

Single-lever automatic bath-shower diverter with flexible and anti-limescale shower handset.
Mitigeur bain-douche avec flexible, inverseur automatique et douchette anti calcaire.
Support orientable.



REFERENCIA PVP
21555 | 104,31 €

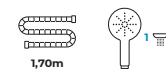

REFERENCIA PVP
21555/0 | 89,27 €



Monomando ducha con flexible, soporte orientable y mango de ducha ABS autoclean.

Single-lever shower with automatic diverter, flexible and anti-limescale shower handset.
Mitigeur douche avec flexible, douchette et support orientable.



REFERENCIA PVP
21424 | 84,18 €

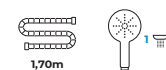

REFERENCIA PVP
21424/0 | 68,91 €





Monomando fregadero con caño giratorio.
Single-lever kitchen mixer with swivel spout.
Mitigeur évier avec bec pivotant.

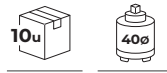

REFERENCIA PVP

21658 | 141,01 €

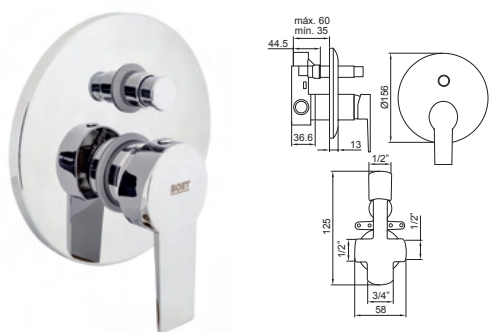

Monomando ducha empotrado con 2 vías sin complementos.
Wall mounted single-lever shower mixer with 2 outlets. Without accessories.
Mitigeur douche encastrable avec 2 sorties. Sans accessoires.



REFERENCIA PVP

21556 | 170,18 €

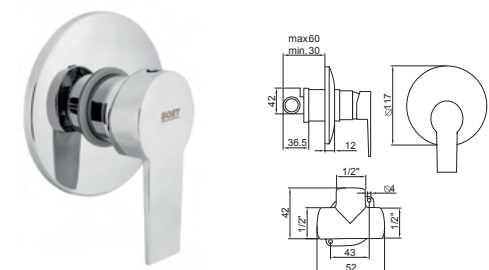

Monomando ducha empotrado de 1 vía sin complementos.
Wall mounted single-lever shower mixer with 1 outlet. Without accessories.
Mitigeur douche encastrable, 1 sortie. Sans accessoires.



REFERENCIA PVP

21425 | 65,28 €

Producto Relacionado

Ref. Shower Set 2

Pack accesorios ducha para empotrados de 2 vías: Brazo pared tubular, rociador redondo \varnothing 20 cm, soporte con toma, flexo y mango de ducha ABS autoclean.

Accessories shower pack for 2 ways wall mounted single-lever: wall arm, 20 cm round shower head, support with water connection, hose and shower handle.

Pack d'accessoires pour douche avec robinets muraux à 2 voies : bras mural, pomme de douche ronde de 200 mm, support avec raccord d'eau, flexible et douchette anti calcaire.





Colección PLAY



Colección de estética moderna y discreta, que se integra de forma armoniosa en cualquier entorno. Certificada por Aenor. Acabados en cromo.

Collection with a modern and discreet aesthetic that blends harmoniously into any environment. Certified by Aenor. Chrome finish.

Collection au design moderne et discret, s'intégrant harmonieusement dans tout environnement. Certifiée par Aenor. Finition chromée.



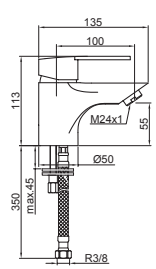

Monomando lavabo.
Single-lever basin mixer.
Mitigeur lavabo.



REFERENCIA PVP
98107 | 59,23 €



REFERENCIA PVP
98108 | 81,18 €

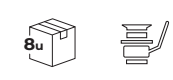

REFERENCIA PVP
98108P | 67,89 €

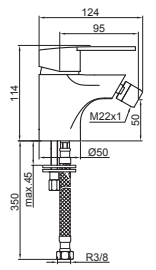

Monomando bidé con rótula giratoria.
Single-lever bidet mixer with directional aerator.
Mitigeur bidet, rotule orientable.



REFERENCIA PVP
98227 | 61,23 €



REFERENCIA PVP
98228 | 81,18 €

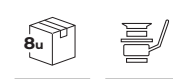

REFERENCIA PVP
98228P | 67,89 €

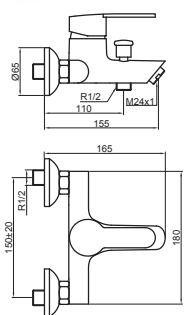
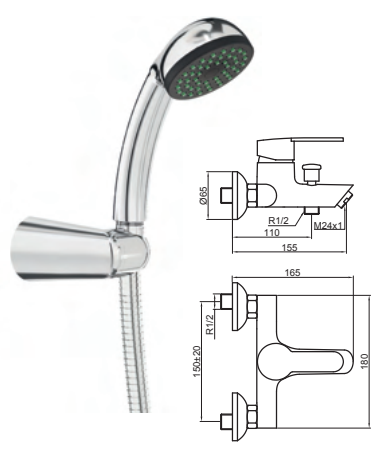

Monomando baño-ducha con inversor automático, soporte orientable, flexo y mango de ducha autoclean.

Single-lever bath-shower mixer with diverter, shower hose, orientable support and anti-limescale shower handset.

Mitigeur bain-douche. Flexible, inverseur automatique, douchette anti calcaire. Support orientable.

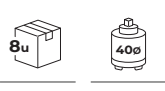

REFERENCIA PVP
98555 | 98,33 €



REFERENCIA PVP
98555/0 | 86,59 €

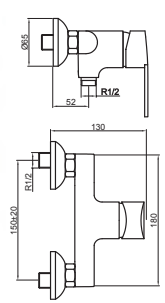

Monomando ducha con flexible, soporte orientable y mango de ducha autoclean.

Single-lever shower mixer with diverter, shower hose, orientable support and anti-limescale shower handset.

Mitigeur douche avec flexible, douchette et support orientable.

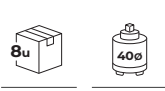

REFERENCIA PVP
98424 | 80,27 €



REFERENCIA PVP
98424/0 | 68,52 €





Colección SEIS



Diseño de carácter familiar, basado en formas redondeadas y elípticas que transmiten suavidad y confort. Funcional y cercana. Certificación AENOR. Acabado en cromo.

Family-oriented design, based on rounded and elliptical shapes that convey softness and comfort. Functional and approachable. AENOR certified. Chrome finish.

Design à caractère familial, basé sur des formes arrondies et elliptiques qui transmettent douceur et confort. Fonctionnelle et conviviale. Certifiée AENOR. Finition chrome.



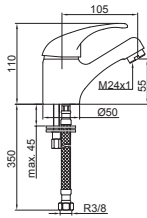

Monomando lavabo.
Single-lever basin mixer.
Mitigeur lavabo.



REFERENCIA PVP

66107 | 57,66 €



REFERENCIA PVP

66108 | 79,62 €

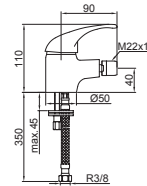

Monomando bidé con rótula giratoria.
Single-lever bidet mixer with directional aerator.
Mitigeur bidet, rotule orientable.



REFERENCIA PVP

66227 | 59,52 €



REFERENCIA PVP

66228 | 81,50 €

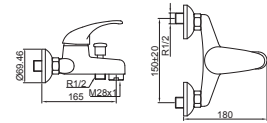

Monomando baño-ducha con inversor automático, soporte orientable, flexo y mango de ducha ABS autoclean.

Single-lever bath-shower mixer with diverter, shower hose, orientable support and anti-limescale shower handset.

Mitigeur bain-douche. Flexible, inverseur automatique, douchette anti calcaire. Support orientable.



REFERENCIA PVP
66555 | 97,74 €



REFERENCIA PVP
66555/0 | 86,13 €

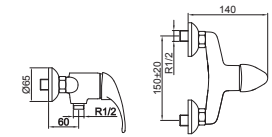

Monomando ducha con flexible, soporte orientable y mango de ducha ABS autoclean.

Single-lever shower mixer with diverter, shower hose, orientable support and anti-limescale shower handset.

Mitigeur douche avec flexible, douchette et support orientable.



REFERENCIA PVP
66424 | 80,10 €



REFERENCIA PVP
66424/0 | 68,32 €

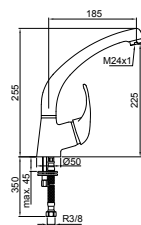

Monomando fregadero con caño fundido giratorio.
Single-lever kitchen mixer with cast swivel spout.
Mitigeur évier avec bec fondu pivotant.



REFERENCIA PVP

66659/09 | 95,39 €

Colección DUO

Diseño fresco y contemporáneo, con personalidad. Incorpora sistema de doble apertura para un control eficiente del consumo de agua. Certificada por Aenor.

Fresh and contemporary design with character. Features a dual-opening system for efficient water consumption control. Certified by AENOR.

Design frais et contemporain, avec de la personnalité. Intègre un système à double ouverture C2 pour un contrôle efficace de la consommation d'eau. Certifié par AENOR.



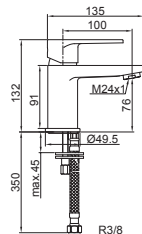

Monomando lavabo con doble apertura.
Single-lever basin mixer with eco-click (two-step).
Mitigeur lavabo laiton avec C2.



REFERENCIA PVP

25107 | 54,67 €

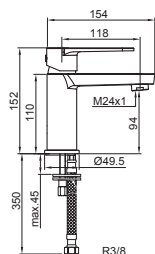

Monomando XL lavabo con doble apertura.
XL single-lever basin mixer with eco-click (two-step).
Mitigeur lavabo XL laiton avec C2.



REFERENCIA PVP

25109 | 64,25 €

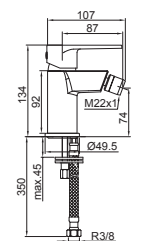

Monomando bidé con rótula giratoria y doble apertura.
Single-lever bidet mixer with directional aerator and eco-click (two-step).
Mitigeur bidet laiton avec rotule orientable et C2.



REFERENCIA PVP

25227 | 57,35 €

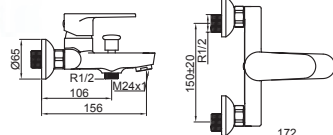

Monomando baño-ducha con doble apertura. Inversor automático, flexo y mango de ducha ABS autoclean.

Single-lever bath-shower mixer with eco-click (two-step), flexible hose, automatic diverter and anti-limescale shower handset.

Mitigeur bain-douche avec C2 laiton. Flexible, inverseur automatique et douchette anti calcaire. Support orientable.

REFERENCIA PVP

25555 | 91,75 €



REFERENCIA PVP

25555/0 | 81,91 €

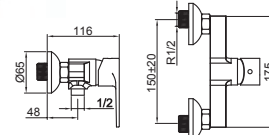

Monomando ducha con doble apertura, flexible, soporte orientable y mango de ducha ABS autoclean.

Single-lever shower mixer with eco-click (two-step), flexible hose and anti-limescale shower handset.

Mitigeur douche laiton avec C2, flexible, douchette et support orientable.

REFERENCIA PVP

25424 | 75,85 €



REFERENCIA PVP

25424/0 | 66,00 €



DUO

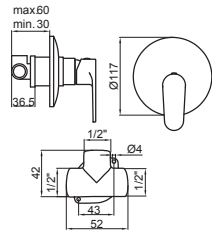

Monomando de ducha empotrado de 1 vía con doble apertura.
 Wall mounted single-lever shower mixer with eco-click (two-step), 1 outlet.
 Mitigeur douche encastrable laiton avec C2, 1 sortie.

REFERENCIA PVP

25425 | 77,20 €

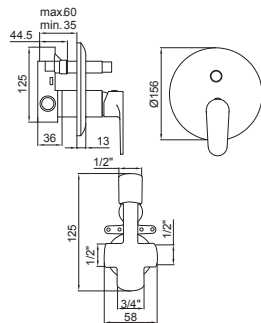

Monomando de ducha empotrado de 2 vías con doble apertura.
 Wall mounted single-lever shower mixer with eco-click (two-step), 2 outlets.
 Mitigeur douche encastrable laiton avec C2, 2 sorties.

REFERENCIA PVP

25556 | 148,67 €

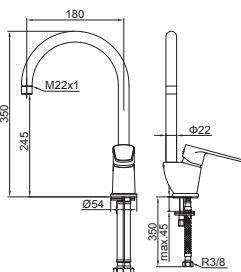

Monomando de cocina con doble apertura y caño alto giratorio.
 Single-lever kitchen mixer eco-click (two-step), with swivel spout.
 Mitigeur évier laiton avec C2, bec pivotant.

REFERENCIA PVP

25657 | 71,46 €

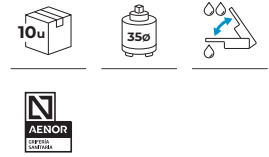



Colección JET



Estética moderna y discreta que fusiona armoniosamente con cualquier espacio. Acabados en cromo. Limitador de caudal ecológico. Certificada por ACS y por Medio Ambiente.

Modern and discreet aesthetic that blends harmoniously with any space. Chrome finish. Equipped with eco flow limiter. Certified by ACS and the Environmental Agency.

Esthétique moderne et discrète qui s'harmonise parfaitement avec tout espace. Finition chrome. Équipée d'un limiteur de débit écologique. Certifiée par l'ACS et par l'Agence de l'Environnement.





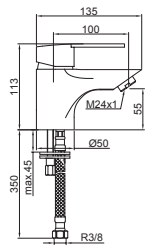

Monomando lavabo, con caudal de 5 l/m.
Single-lever basin mixer with 5 l/m flow rate.
Mitigeur lavabo.



REFERENCIA PVP

96107 | 51,77 €



REFERENCIA PVP

96108 | 73,74 €

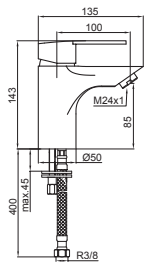

Monomando lavabo XL, con caudal de 5 l/m.
Extended height single-lever basin mixer with 5 l/m flow rate.
Mitigeur lavabo haut.



REFERENCIA PVP

96109 | 63,02 €



REFERENCIA PVP

96109/V | 85,01 €

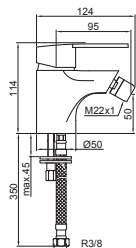

Monomando bidé con rótula giratoria.
Single-lever bidet mixer with directional aerator.
Mitigeur bidet, rotule orientable.



REFERENCIA PVP

96227 | 53,24 €



REFERENCIA PVP

96228 | 75,23 €



Monomando baño-ducha con inversor automático, soporte orientable, flexo y mango de ducha ABS autoclean.

Single-lever automatic bath-shower diverter with flexible and anti-limescale shower handset.

Mitigeur bain-douche. Flexible, inverseur automatique, douchette anti calcaire. Support orientable.

REFERENCIA PVP

96555 | 90,58 €



REFERENCIA PVP

96555/0 | 79,09 €

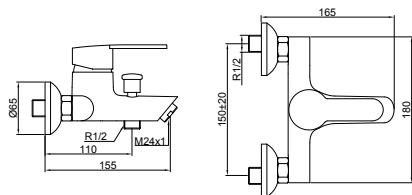

Adaptable a nivel BSC 5

Producto Relacionado



Ref. 91056F

Sifón de latón cilíndrico.

Brass siphon.

Siphon laiton.



Monomando ducha con flexible, soporte orientable y mango de ducha ABS autoclean. Caudal de 8 l/m.

Single-lever with automatic shower diverter, anti-limescale shower handset and 8 l/m flow rate.

Mitigeur douche, flexible, douchette et support orientable.



REFERENCIA	PVP
96424	73,26 €

REFERENCIA	PVP
96424/0	61,84 €



Monomando ducha empotrado con 2 vías sin complementos.

Wall mounted single-lever shower mixer with 2 ways. Without accessories.

Mitigeur douche encastrable avec 2 sorties. Sans accessoires.



REFERENCIA	PVP
96556	150,42 €



Monomando ducha empotrado de 1 vía sin complementos.

Wall mounted single-lever shower mixer with 1 outlet. Without accessories.

Mitigeur douche encastrable, 1 sortie. Sans accessoires.



REFERENCIA	PVP
96425	70,21 €

PACK 96 WALL



PACK 96 TOP



Pack monomando ducha empotrada de 2 vías con accesorios: brazo de pared, rociador redondo, soporte integrado con toma de agua, flexo y mango de ducha ABS autoclean.

Bathroom tap pack wall mounted single-lever with 2 ways push: shower arm, round fixed overhead shower head, integrated shower outlet elbow and handset holder, shower hose and handset.

Pack pour douche encastrée, avec 2 sorties push: bras mural, tête de pluie ronde, coude de raccordement mural avec support, flexible de douche et douchette.



REFERENCIA	PVP
Pack 96 Wall	279,47 €

REFERENCIA	PVP
Pack 96 Top	281,16 €

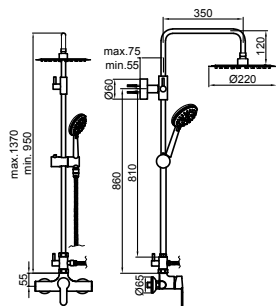

Barra de ducha vista telescópica monomando, inversor de 2 vías, rociador redondo ABS autoclean, flexo y mango ducha ABS autoclean. Caudal de 12 l/m.

Single-lever round slide bar shower mixer kit, diverter, ABS auto clean hand shower and ABS auto clean round overhead.

Barre de douche extensible, avec mitigeur, inverseur 2 sorties, pomme de douche ronde ABS autoclean et douchette ABS autoclean.

REFERENCIA PVP

96430/C | 274,43 €

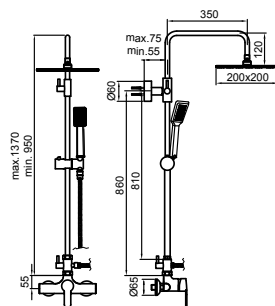
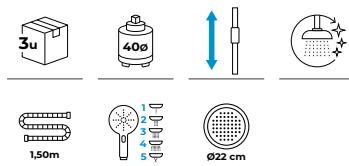

Barra de ducha vista telescópica monomando, inversor de 2 vías, rociador cuadrado inox 3 mm, 20 x 20 cm, flexo y mango ducha ABS autoclean. Caudal de 12 l/m.

Single-lever round slide bar shower mixer kit, diverter, ABS auto clean hand shower and inox 3 mm squared overhead.

Barre de douche extensible, avec mitigeur, inverseur 2 sorties, pomme de douche carrée inox 3 mm et douchette ABS autoclean..

REFERENCIA PVP

96430/2 | 366,07 €

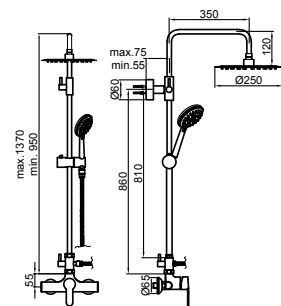
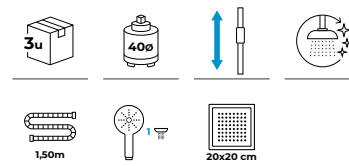

Barra de ducha vista telescópica monomando, inversor de 2 vías, rociador redondo inox 3 mm, flexo y mango ducha ABS autoclean. Caudal de 12 l/m.

Single-lever round slide bar shower mixer kit, diverter, ABS auto clean hand shower and inox 3 mm round overhead.

Barre de douche extensible, avec mitigeur, inverseur 2 sorties, pomme de douche ronde inox 3 mm et douchette ABS autoclean.

REFERENCIA PVP

96430/3 | 366,07 €

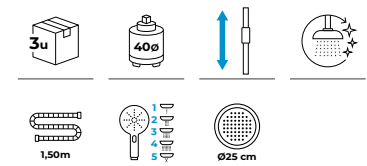

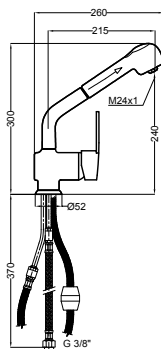

Monomando fregadero con caño giratorio inclinado y ducha extraíble.

Pull-out single-lever kitchen mixer and swivel spout.

Mitigeur évier avec bec pivotant.

REFERENCIA PVP

96670 | 190,84 €

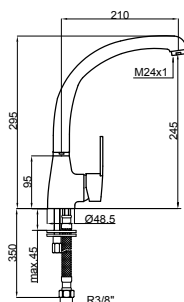

Monomando fregadero con caño giratorio y caudal de 5 l/m.

Single-lever kitchen mixer with swivel spout. Flow rate 5 l/m.

Mitigeur évier avec bec pivotant. Débit écologique.

REFERENCIA PVP

96658 | 72,25 €



Adaptable a nivel BSC 5

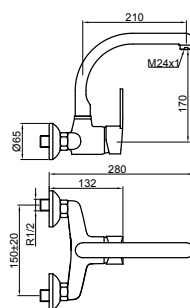

Monomando fregadero mural con caño giratorio.

Single-lever kitchen mixer with swivel spout.

Mitigeur évier avec bec pivotant.

REFERENCIA PVP

96651 | 101,35 €

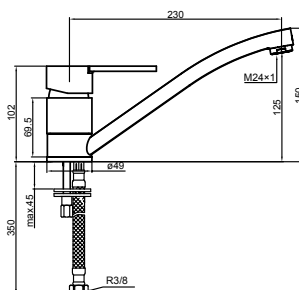

Monomando fregadero con caño inclinado giratorio.

Single-lever kitchen mixer with swivel spout.

Mitigeur évier avec bec pivotant.

REFERENCIA PVP

96660 | 62,32 €



Colección CINCO



Diseño distintivo, armonía de formas suaves y esbeltas que transforman tu espacio creando un ambiente relajado y apacible. Con acabados en cromo, esta colección incorpora un amplio surtido de grifos de cocina.

Distinctive design, a harmony of smooth and slender shapes that transform your space into a calm and relaxing environment. With chrome finish, this collection includes a wide range of kitchen mixers.

Design distinctif, harmonie de formes douces et élancées qui transforment votre espace en un environnement paisible et relaxant. Avec une finition chromée, cette collection comprend une large gamme de mitigeurs de cuisine.



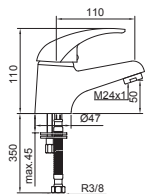

Monomando lavabo.
Single-lever basin mixer.
Mitigeur lavabo.



REFERENCIA	PVP
65107	48,46 €



REFERENCIA	PVP
65108	70,45 €

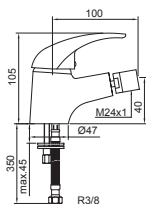

Monomando bidé con rótula giratoria.
Single-lever bidet mixer with directional aerator.
Mitigeur bidet, rotule orientable.



REFERENCIA	PVP
65227	48,46 €



REFERENCIA	PVP
65228	70,45 €

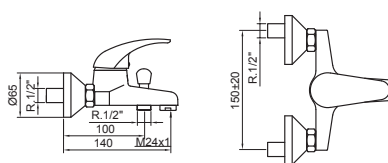

Monomando baño-ducha con inversor automático, soporte orientable, flexo y mango de ducha ABS autoclean.

Single-lever bath-shower with automatic diverter, flexible and anti-limescale shower handset.

Mitigeur bain-douche. Flexible, inverseur automatique, douchette anti calcaire. Support orientable.



REFERENCIA	PVP
65555	77,49 €



REFERENCIA	PVP
65555/0	67,75 €



Monomando ducha, con flexible, soporte orientable y mango de ducha ABS autoclean.

Single-lever with automatic shower diverter, hose and anti-limescale shower handset.

Mitigeur douche, flexible, douchette et support orientable.



REFERENCIA	PVP
65424	67,64 €



REFERENCIA	PVP
65424/0	58,32 €

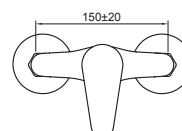
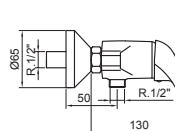

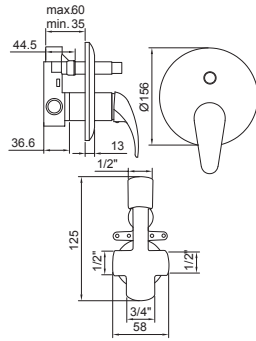

Monomando ducha empotrado con 2 vías sin complementos.

Wall mounted single-lever shower mixer with 2 outlets. Without accessories.

Mitigeur douche encastrable avec 2 sorties. Sans accessoires.



REFERENCIA PVP

65556 | 142,90 €

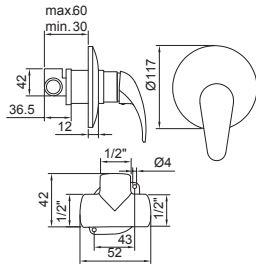

Monomando ducha empotrado de 1 vía sin complementos.

Wall mounted single-lever shower mixer with 1 outlet. Without accessories.

Mitigeur douche encastrable, 1 sortie. Sans accessoires.



REFERENCIA PVP

65425 | 66,61 €

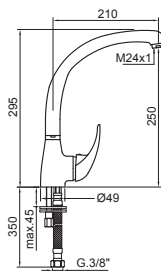

Monomando fregadero con caño giratorio conformado.

Single-lever kitchen mixer with swivel spout.

Mitigeur évier avec bec pivotant.

REFERENCIA PVP

65658/08 | 67,04 €

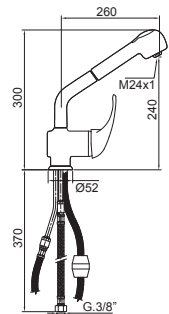
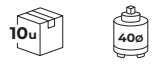

Monomando fregadero con caño giratorio inclinado y ducha extraíble. Caudal de 9,5 l/m.

Pull-out single-lever kitchen mixer with swivel spout.

Mitigeur évier avec bec pivotant.

REFERENCIA PVP

65670 | 188,15 €

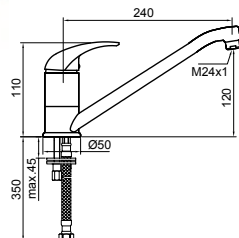

Monomando fregadero con caño giratorio inclinado.

Single-lever kitchen mixer with swivel spout.

Mitigeur évier avec bec pivotant.

REFERENCIA PVP

65660 | 61,05 €

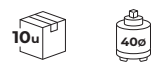

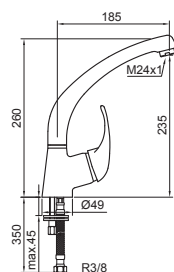

Monomando fregadero con caño fundido giratorio.

Single-lever kitchen mixer with cast swivel spout.

Mitigeur évier avec bec fondu pivotant.

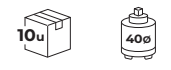

REFERENCIA PVP

65659/09 | 95,39 €

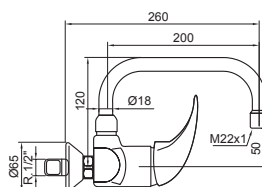

Monomando fregadero con caño giratorio a pared.

Caudal de 10 l/m.

Single-lever kitchen mixer with U swivel spout.

Mitigeur évier avec bec en U pivotant.

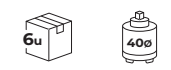

REFERENCIA PVP

65651/58 | 118,48 €

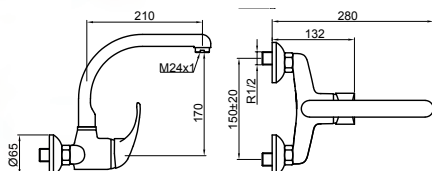

Monomando fregadero con caño giratorio a pared.

Single-lever kitchen mixer with U swivel spout.

Mitigeur évier avec bec en U pivotant.

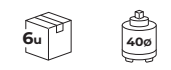

REFERENCIA PVP

65624/60 | 108,43 €

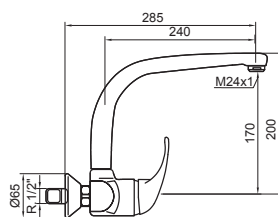

Monomando fregadero con caño fundido giratorio, a pared.

Single-lever kitchen mixer with cast swivel spout.

Mitigeur évier avec bec fondu pivotant.

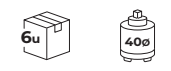

REFERENCIA PVP

65652/06 | 122,15 €

Producto Relacionado



Ref. 91056F

Sifón de latón cilíndrico.

Brass siphon.

Siphon laiton.

Colección COCINAS



Funcionalidad y diseño se unen en nuestra colección de griferías de cocina. Un amplio abanico de modelos con diferentes formas, funciones y acabados que se adaptan a cada espacio y estilo. Desde opciones para ósmosis hasta caños flexibles, extraíbles o abatibles, todas pensadas para ofrecer comodidad, estética y tecnología al servicio del día a día.

Functionality and design come together in our kitchen faucet collection. A wide range of models with diverse shapes, functions, and finishes that adapt to every space and style. From options for osmosis systems to flexible, pull-out, or fold-down spouts, each one designed to bring comfort, aesthetics, and technology to your everyday life.

Fonctionnalité et design s'unissent dans notre collection de robinetterie de cuisine. Une large gamme de modèles aux formes, fonctions et finitions variées, capables de s'adapter à chaque espace et style. Des options pour l'osmose jusqu'aux becs flexibles, extractibles ou rabattables, toutes pensées pour offrir confort, esthétique et technologie au service du quotidien.





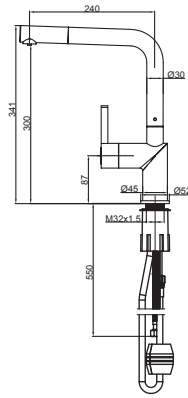

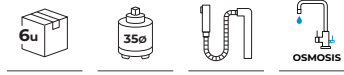

Monomando de cocina de 3 vías con caño extraíble y botón push para osmosis. Caudal de 12 l/m.
Three-way single-lever sink mixer with pull-out spout and push button for osmosis. Flow rate 12 l/min.
Mitigeur monocommande évier 3 voies avec bec extractible et bouton push pour osmose. Débit 12 l/min.



REFERENCIA PVP

 82701	229,89 €
 82701/N	232,45 €

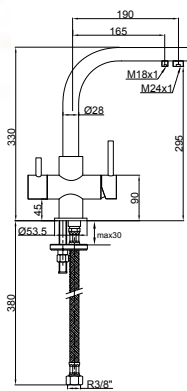

Grijo de cocina de 3 vías compatible con sistemas de osmosis. Montura cerámica de 1/4" vuelta.
Three-way kitchen tap compatible with osmosis systems. 1/4 turn ceramic headwork.
Robinet de cuisine 3 voies compatible avec les systèmes d'osmose. Tête céramique 1/4 de tour.



REFERENCIA PVP

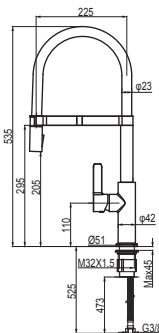

 82700	278,86 €
---	----------



Monomando de cocina de 3 vías con caño flexible y salida osmosis. Caudal de 12 l/m.
Three-way single-lever sink mixer with flexible spout and osmosis outlet. Flow rate 12 l/min.
Mitigeur monocommande évier 3 voies avec bec flexible et sortie osmose. Débit 12 l/min.



REFERENCIA PVP

 82702	231,55 €
 82702/N	234,80 €
 82702/G	257,55 €



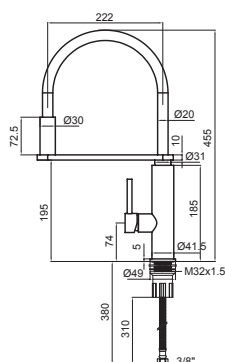

Monomando de cocina cromado con caño giratorio flexible de silicona suave. Caudal 6,2 l/m.

Kitchen single-lever mixer with flexible swivel spout made of soft silicone. Flow rate: 6.2 l/min.

Mitigeur cuisine laiton avec bec siliconé flexible et doux au toucher. Débit 6,2 l/m.



REFERENCIA PVP

	82693/A	235,19 €
	82701/B	235,19 €
	82701/N	235,19 €
	82701/R	235,19 €

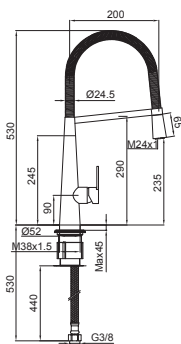

Monomando de cocina con caño de muelle extensible, apertura en frío y doble apertura con caudal mínimo de 4,6 l/m.

Single-lever kitchen mixer with flexible spout, two-step water saver, cold start and eco flow.

Mitigeur évier, bec flexible, C2, C3 et débit écologique.



REFERENCIA PVP

	26692	242,16 €
--	-------	----------

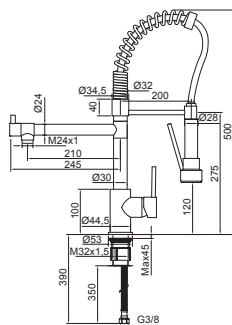

Monomando de cocina con 2 vías, chorro y rociador con ducha y caño giratorio abatible de muelle. Altura 500 mm. Caudales: duchita, 9 l/m, caño 10,5 l/m.

Two-way kitchen single-lever mixer with dual spray (jet and shower), pull-out hand shower and spring swivel and foldable spout. Height 500 mm. Flow rates: hand shower 9 l/min, spout 10.5 l/min.

Mitigeur monocommande cuisine à 2 voies avec double jet (mousseur et douche), douchette extractible et bec orientable et rabattable à ressort. Hauteur 500 mm. Débits : douchette 9 l/min, bec 10,5 l/min.

REFERENCIA PVP

	82690/07	358,42 €
--	----------	----------



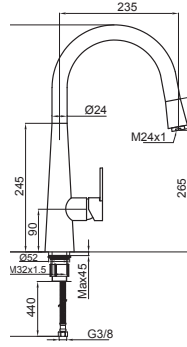

Monomando de cocina con ducha extraíble, apertura en frío, y doble apertura con caudal mínimo de 5,6 l/m.

Single-lever kitchen mixer with pull-out spout, two-step water saver, cold start and eco flow.

Mitigeur évier, bec extractible, C2, C3 et débit écologique.

REFERENCIA PVP



26681

229,29 €

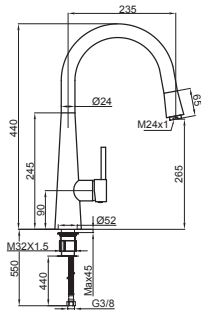
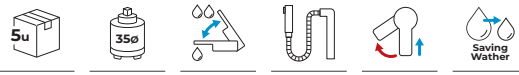

Monomando de cocina con caño de latón giratorio y flexo extraíble con ducha.

Single-lever sink mixer with swivel brass spout and pull-out hose with hand shower.

Mitigeur monocommande évier avec bec orientable en laiton et flexible extractible avec douchette.

REFERENCIA PVP



82681

228,76 €

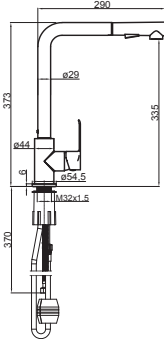

Monomando de cocina con ducha extraíble y apertura en frío. Caudal de 7,1 l/m.

Single-lever sink mixer with pull-out shower and Gentle Cold Start. Flow rate 7.1 l/min.

Mitigeur évier avec douchette extractible et ouverture sur l'eau froide C3. Débit 7,1 l/min.

REFERENCIA PVP



55671

131,47 €



55671/N

142,56 €

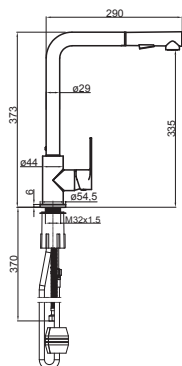
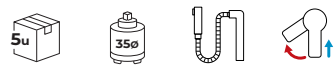

Monomando de cocina con ducha extraíble y apertura en frío. Caudal de 7,1 l/m.

Single-lever kitchen mixer with pull-out hand shower and cold start. Flow rate 7.1 l/min.

Mitigeur monocommande cuisine avec C3 et douchette extractible. Débit 7,1 l/min.

REFERENCIA PVP



39671

131,47 €



39671/N

140,90 €

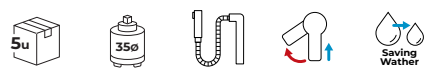

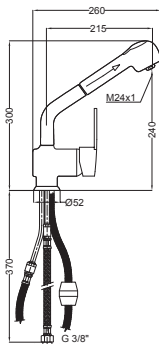

Monomando de cocina con caño giratorio inclinado y ducha extraíble.

Pull-out single-lever kitchen mixer and swivel spout.

Mitigeur évier avec bec pivotant.



REFERENCIA PVP



96670

190,84 €

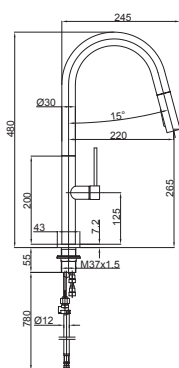

Monomando de cocina con caño alto, flexo extraíble, duchita y conexión imantada. Con apertura en frío y caudal 6,9 l/m.

Single-lever kitchen mixer with high spout, pull-out hose, hand shower, and magnetic connection. Equipped with cold-start system and 6.9 l/min flow rate.

Mitigeur évier laiton, cartouche C3, avec bec extractible. Support de douchette magnétique. Débit 6,9 l/m.



REFERENCIA PVP



40673

162,84 €



40673/N

178,84 €



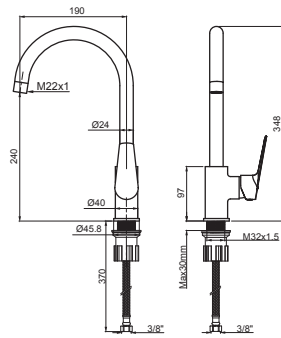

Monomando de cocina con apertura en frío y caño giratorio. Caudal de 5 l/m.

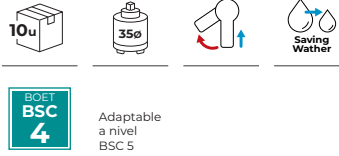

Single lever kitchen mixer, cold start, with swivel spout. 5 l/min flow rate.

Mitigeur évier, ouverture à froid, bec orientable. Débit de 5 l/min.



BIOMET BSC 4 Adaptable a nivel BSC 5

REFERENCIA PVP

	56657	57,06 €
	56657/N	63,80 €
	56657/G	84,22 €

NOVEDAD

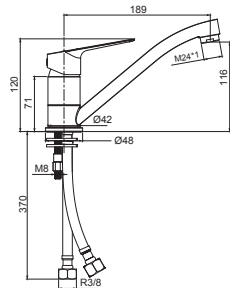

Monomando de cocina con caño horizontal giratorio.

Single lever kitchen mixer with horizontal swivel spout.

Mitigeur évier avec bec horizontal orientable.



BIOMET BSC 4 Adaptable a nivel BSC 5

REFERENCIA PVP

	56660	41,25 €
---	-------	---------

NOVEDAD

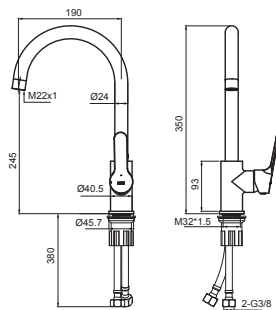

Monomando de cocina con apertura en frío y caño giratorio. Caudal de 5 l/m.

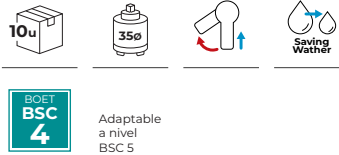

Single lever kitchen mixer, cold start, with swivel spout. 5 l/min flow rate.

Mitigeur évier, ouverture à froid, bec orientable. Débit de 5 l/min.



BIOMET BSC 4 Adaptable a nivel BSC 5

REFERENCIA PVP

	57657	57,06 €
	57657/N	63,80 €
	57657/G	84,22 €

NOVEDAD

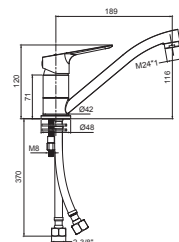

Monomando de cocina con caño horizontal giratorio.

Single lever kitchen mixer with horizontal swivel spout.

Mitigeur évier avec bec horizontal orientable.



BIOMET BSC 4 Adaptable a nivel BSC 5

REFERENCIA PVP

	57660	41,25 €
---	-------	---------

NOVEDAD

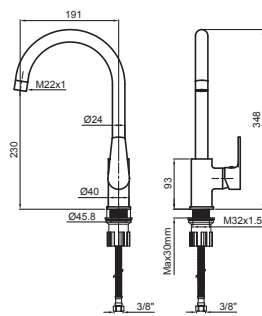

Monomando de cocina con caño giratorio. Caudal de 5 l/m.
 Single lever sink mixer with swivel spout. 5 l/min flow rate.
 Mitigeur évier avec bec orientable. Débit de 5 l/min.



Adaptable a nivel BSC 5

REFERENCIA PVP



38657

57,06 €



38657/N

63,80 €

NOVEDAD

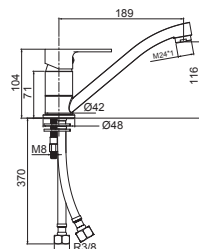

Monomando de cocina con caño horizontal giratorio.
 Single lever kitchen mixer with horizontal swivel spout.
 Mitigeur cuisine avec bec horizontal orientable.



REFERENCIA PVP



38660

41,25 €

NOVEDAD

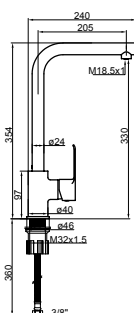

Monomando de cocina con apertura en frío y caño giratorio. Caudal de 5 l/m.
 Single-lever sink mixer with Gentle Cold Start and swivel spout. Flow rate 5 l/min.
 Mitigeur évier avec ouverture sur l'eau froide C3 et bec orientable. Débit 5 l/min.



Adaptable a nivel BSC 5

REFERENCIA PVP



55657

71,85 €



55657/N

82,74 €

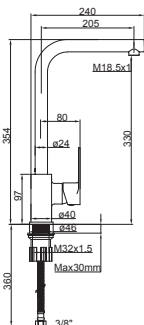

Monomando de cocina con apertura en frío y caño giratorio.
 Caudal de 5 l/m.
 Single-lever kitchen mixer, cold start and swivel spout. Flow rate 5 l/min.
 Mitigeur monocommande cuisine avec C3 et bec orientable. Débit 5 l/min.



Adaptable a nivel BSC 5

REFERENCIA PVP



39657

72,35 €



39657/N

82,74 €

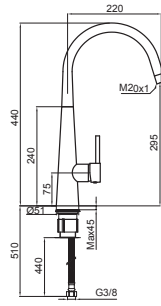

Monomando de cocina con caño de latón cuello de cisne giratorio.
 Single-lever sink mixer with swivel gooseneck brass spout.
 Mitigeur monocommande évier avec bec col de cygne orientable en laiton.

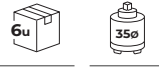

REFERENCIA PVP
 82659 | 162,45 €

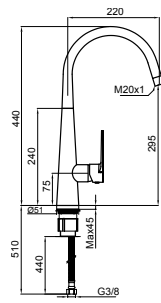

Monomando de cocina con caño giratorio, apertura en frío, y doble apertura con caudal mínimo de 5,2 l/m.
 Single-lever kitchen mixer with swivel spout, two-step water saver, cold start and eco flow.
 Mitigeur évier, bec pivotant, avec C2, C3 et débit écologique.

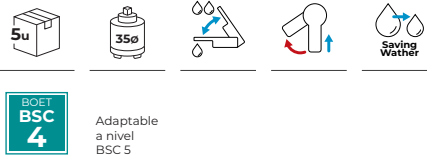

REFERENCIA PVP
 26659 | 164,93 €

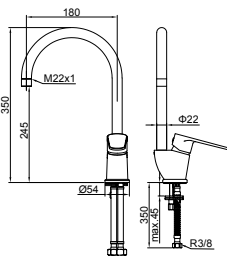

Monomando de cocina con caño giratorio y caudal de 5 l/m.
 Single-lever kitchen mixer with swivel spout, flow rate 5 l/m.
 Mitigeur évier avec bec pivotant. Débit 5 l/m.



REFERENCIA PVP
 14657 | 63,05 €
 14657/N | 81,27 €

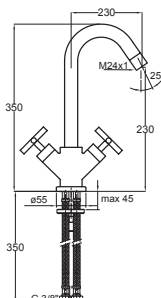

Mezclador bimando de cocina con caño giratorio cuello de cisne. Montura cerámica 1/2" vuelta.
 Twin-lever kitchen mixer with swan neck swivel spout.
 Mélangeur évier, bec de cygne pivotant.



REFERENCIA PVP
 74657/11 | 239,93 €

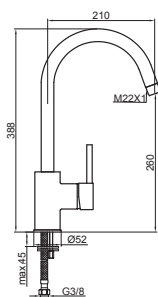

Monomando de cocina con caño cuello de cisne giratorio.
 Single-lever sink mixer with swivel gooseneck spout.
 Mitigeur monocommande évier avec bec col de cygne orientable.

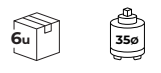

REFERENCIA PVP

82657/07 | 132,74 €

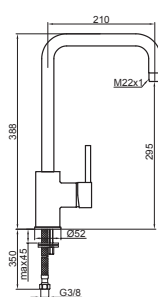

Monomando de cocina con caño cuadrado giratorio.
 Single-lever sink mixer with swivel square spout.
 Mitigeur monocommande évier avec bec carré orientable.

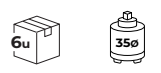

REFERENCIA PVP

82658/08 | 132,74 €

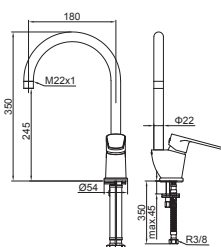

Monomando de cocina con doble apertura y caño alto giratorio.
 Single-lever kitchen mixer eco-click (two-step), with swivel spout.
 Mitigeur évier laiton avec C2, bec pivotant.

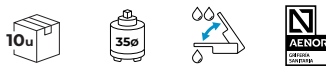

REFERENCIA PVP

25657 | 71,46 €



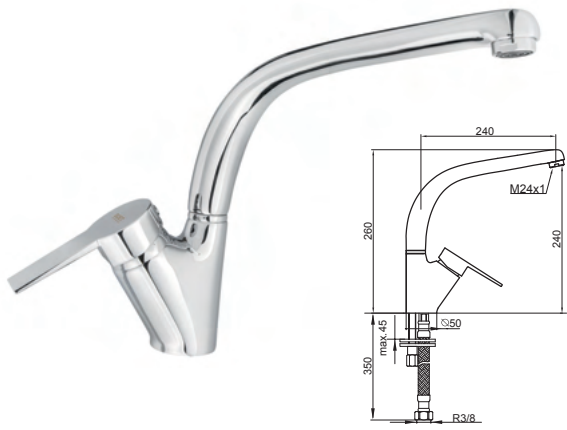

Monomando de cocina con caño giratorio.
 Single-lever sink mixer with swivel spout.
 Mitigeur monocommande évier avec bec orientable.

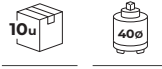

REFERENCIA PVP

21658 | 141,01 €

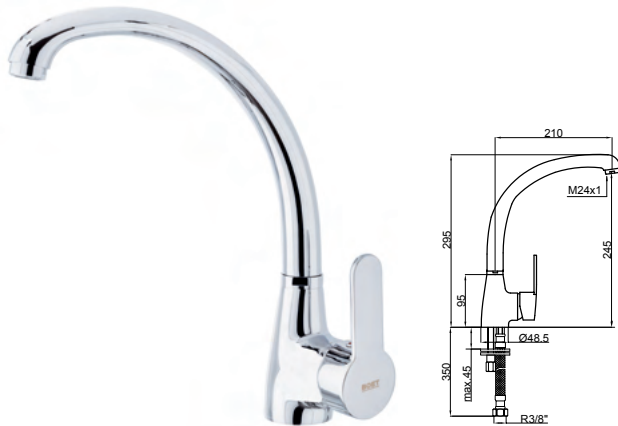

Monomando de cocina con caño giratorio y caudal de 5 l/m.
 Single-lever kitchen mixer with swivel spout. Flow rate 5 l/m.
 Mitigeur évier avec bec pivotant. Débit écologique.



REFERENCIA PVP

96658 | 72,25 €

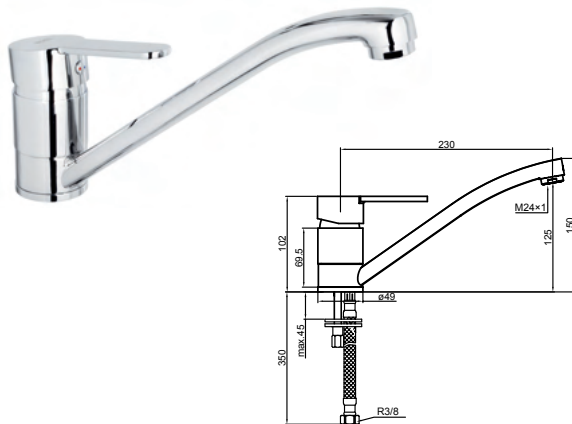

Monomando de cocina con caño inclinado giratorio.
 Single-lever kitchen mixer with swivel spout.
 Mitigeur évier avec bec pivotant.



REFERENCIA PVP

96660 | 62,32 €



Monomando de cocina con caño giratorio.
 Single-lever kitchen mixer with swivel spout.
 Mitigeur évier avec bec pivotant.



REFERENCIA PVP

94658 | 134,63 €



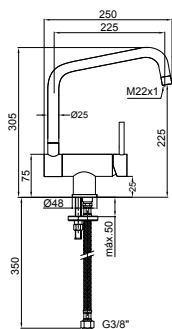

Monomando de cocina con caño de latón abatible para instalación frente a ventana.

Single-lever sink mixer with foldable brass spout for installation in front of a window.

Mitigeur monocommande évier avec bec rabattable en laiton pour installation devant une fenêtre.



REFERENCIA PVP

82710

126,05 €

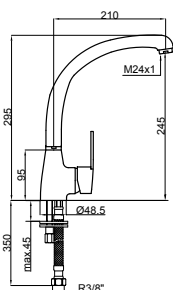

Monomando de cocina con caño giratorio conformado.

Single-lever kitchen mixer with swivel spout.

Mitigeur évier avec bec pivotant.



REFERENCIA PVP

98658

77,33 €



Colección

COLUMNAS DE DUCHA



Descubre nuestra selección de columnas de ducha, diseñadas para transformar cada baño en un espacio de bienestar. Equipadas con todos los elementos necesarios para una experiencia completa, integran tecnologías exclusivas que garantizan confort, seguridad y funcionalidad. Sus excelentes acabados permiten crear ambientes sofisticados y plenamente personalizados, elevando la ducha a un nuevo nivel de estilo.

Discover our selection of shower columns, designed to transform any bathroom into a space of well-being. Equipped with all the necessary elements for a complete experience, they incorporate exclusive technologies that ensure comfort, safety, and functionality. Their excellent finishes allow you to create sophisticated and fully personalized environments, elevating the shower to a new level of style.

Découvrez notre sélection de colonnes de douche, conçues pour transformer chaque salle de bains en un espace de bien-être. Équipées de tous les éléments nécessaires pour une expérience complète, elles intègrent des technologies exclusives garantissant confort, sécurité et fonctionnalité. Leurs excellentes finitions permettent de créer des ambiances sophistiquées et entièrement personnalisées, élevant la douche à un nouveau niveau de style.











COLUMNAS



REFERENCIA PVP

-  82430/3 | 278,59 €
-  82430/3/N | 325,40 €
-  82430/3/NQ | 529,35 €
-  82430/3/G | 529,35 €
-  82430/3/BC | 615,89 €
-  82430/3/RG | 585,42 €

Tube: Columna de ducha monomando telescópica, inversor integrado de 2 posiciones, con flexo, rociador redondo INOX Ø 25 cm Slim y mango ducha ABS autoclean.

Single-lever round slide bar shower mixer kit, built-in diverter, ABS auto clean hand shower and round inox 3 mm overhead.

Colonne de douche extensible, avec mitigeur, inverseur intégré 2 sorties, pomme de douche ronde inox autoclean, flexible et douchette anti calcaire.



REFERENCIA PVP

-  82430/3/2 | 282,45 €

Tube: Columna de ducha monomando telescópica, inversor integrado de 2 posiciones, con flexo, rociador cuadrado inox 3 mm grosor, 20 x 20 cm y mango ducha ABS autoclean.

Single-lever round slide bar shower mixer kit, built-in diverter, ABS auto clean hand shower and squared inox 3 mm overhead.

Colonne de douche extensible, avec mitigeur, inverseur intégré 2 sorties, pomme de douche ronde inox autoclean, flexible et douchette anti calcaire.

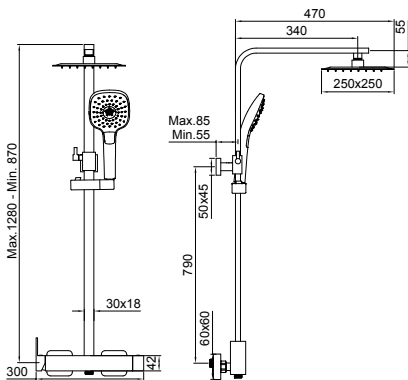
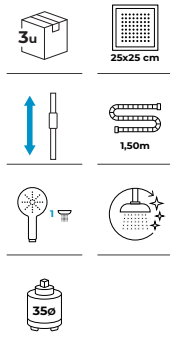

REFERENCIA PVP

47430 | 425,27 €

Esla: Columna de ducha monomando telescópica cuadrada con dos vías, rociador cuadrado inox, flexo y mango de ducha ABS autoclean.

Shower two ways, overhead and hand shoulder slide bar mixer kit.

Colonne de douche extensible carrée avec mitigeur, inverseur 2 sorties, pomme de douche carrée inox, flexible et douchette anti calcaire.

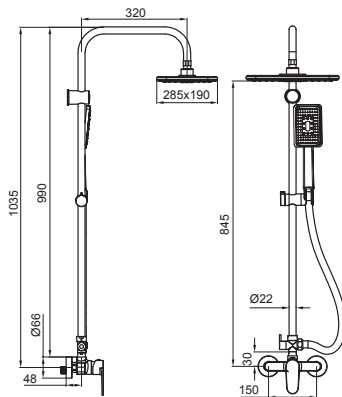
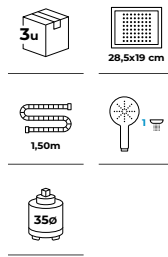

REFERENCIA PVP

14430 | 206,94 €

Luca: Columna de ducha fija con monomando, inversor de 2 vías, rociador rectangular ABS autoclean y mango ducha ABS autoclean.

Single-lever round fixed bar shower mixer kit, diverter, hose, ABS auto clean hand shower and ABS auto clean squared overhead.

Barre de douche, avec mitigeur, inverseur 2 sorties, pomme de douche carrée ABS autoclean et douchette ABS autoclean.



COLUMNAS

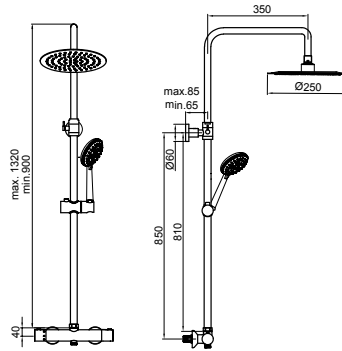

REFERENCIA PVP

-  44431 | 334,39 €
-  44431/N | 487,33 €
-  44431/NQ | 529,50 €
-  44431/G | 529,35 €
-  44431/BC | 615,89 €
-  44431/RG | 585,42 €

Termoline: Columna de ducha vista telescópica termostática de dos vías, rociador redondo INOX, flexo y mango de ducha autoclean. Sistema cool touch, sistema de tope de temperatura a 38°C y sistema de corte de seguridad.

Telescopic thermostatic shower column with two outlets, round INOX shower head, flexible hose and autoclean hand shower. Cool touch system, 38°C safety stop and safety shut-off system.

Colonne de douche thermostatique telescopique à deux sorties avec pommeau rond en acier inoxydable, flexible et douchette. Système Cool Touch, limiteur de température à 38 °C et système d'arrêt de sécurité.

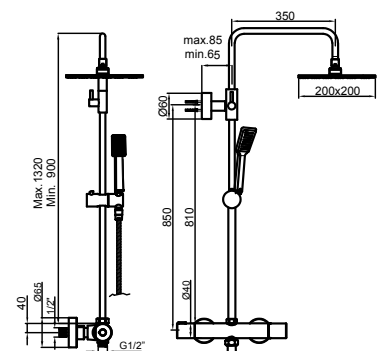

REFERENCIA PVP

-  44431/2 | 338,25 €

Termoline: Columna de ducha telescópica termostática con dos vías, con flexo, rociador y mango de ducha cuadrados. Sistema cool touch, sistema de tope de temperatura a 38°C y sistema de corte de seguridad.

Shower 2 ways (squared overhead and hand shower) slide bar. Thermostatic shower mixer with cool touch system, safety stop at 38°C and supply fail protection.

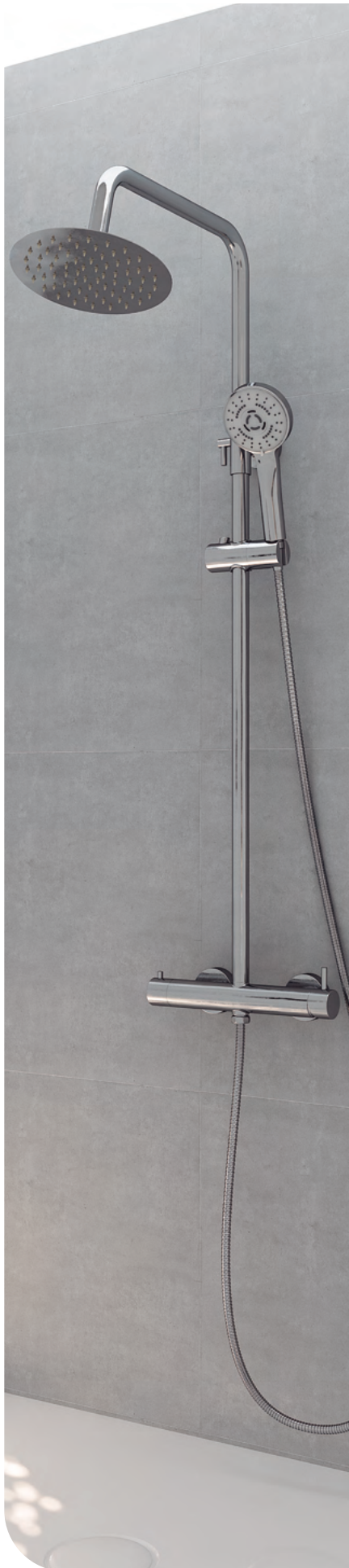

Colonne de douche thermostatique telescopique à deux sorties avec pommeau rond en acier inoxydable, flexible et douchette. Système Cool Touch, limiteur de température à 38 °C et système d'arrêt de sécurité.

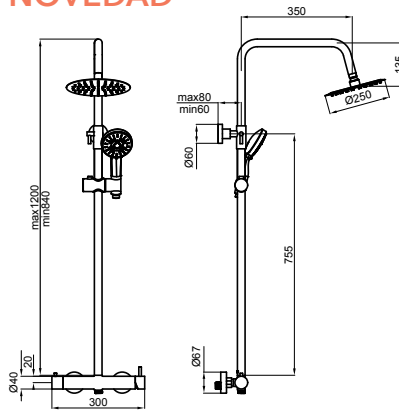

NOVEDAD



REFERENCIA PVP

-  50430 | 199,50 €
-  50430/N | 229,50 €

Sena: Columna de ducha monomando telescópica con inversor integrado de 2 posiciones, rociador INOX ø 25 cm Slim y mango de ducha ABS autoclean.

Single-lever slide bar shower mixer kit, built-in diverter, ABS auto clean hand shower and round inox 3 mm Slim, ø 25 cm overhead.

Colonne de douche extensible, avec mitigeur, inverseur intégré 2 sorties, pomme de douche ronde inox Slim ø 25 cm autoclean et douchette anti calcaire.

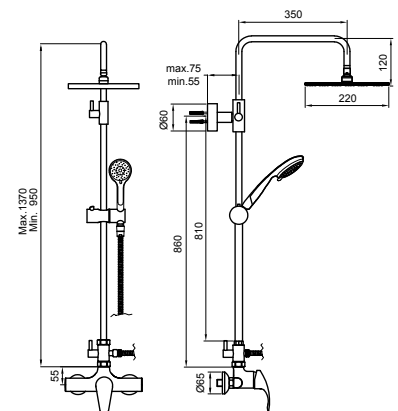
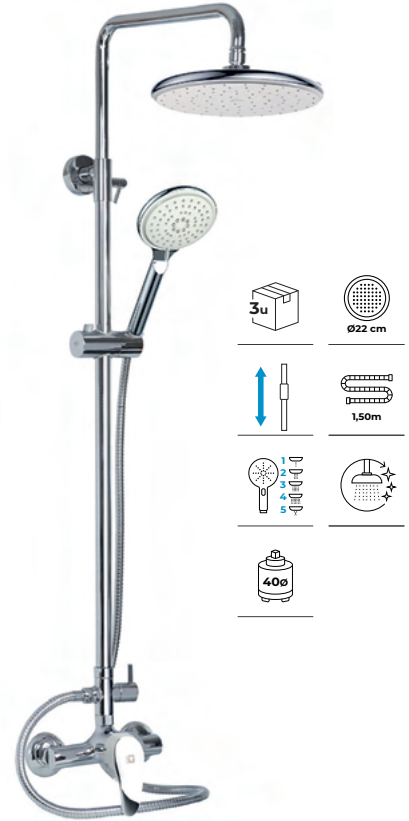

REFERENCIA PVP

-  80430MX | 367,00 €

Trianon: Columna de ducha vista telescópica con monomando, selector de función, rociador, flexo y mango de ducha autoclean.

Shower mixer set, height adjustable mixer shower system with single-lever and selector, round ABS overhead rainfall and high pressure 2 jets ABS handled shower.

Colonne de douche extensible, avec Colonne de douche extensible, avec mitigeur et sélecteur, pomme de douche et douchette anti calcaires.

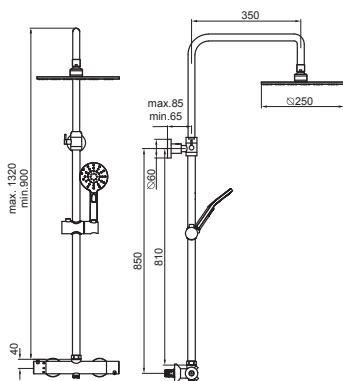
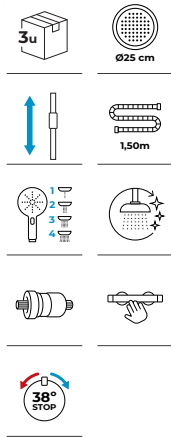

REFERENCIA PVP

44430/3 | 442,95 €

Termosol: columna de ducha telescópica termostática con dos vías, inversor integrado, rociador inox redondo 3 mm, flexo y mango de ducha ABS autoclean. Sistema cool touch, sistema de tope de temperatura a 38°C y sistema de corte de seguridad.

Cool touch thermostatic round slide bar shower mixer kit, built-in diverter, flexible hose, ABS hand shower and round ABS overhead.

Colonne de douche extensible avec mitigeur thermostatique cool touch, inverseur intégré, pomme de douche ronde inox 3 mm, flexible et douchette 3 positions anti calcaire.

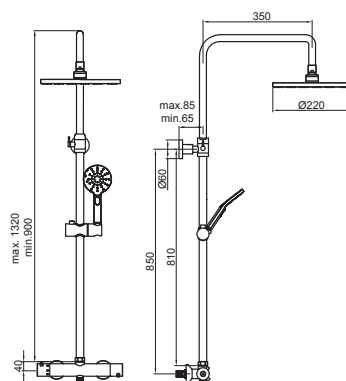
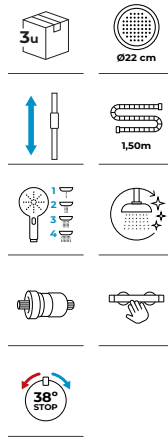
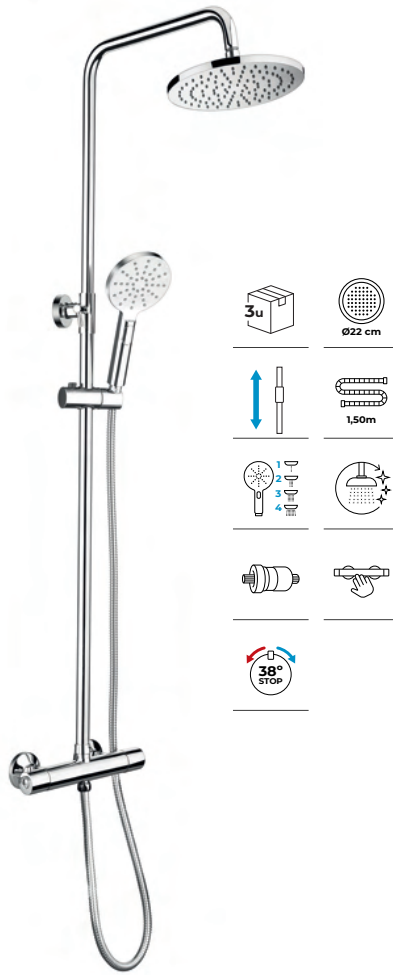

REFERENCIA PVP

44430 | 351,31 €

Termosol: Columna de ducha telescópica termostática con dos vías, inversor integrado, rociador ABS redondo, flexo y mango de ducha ABS autoclean. Sistema cool touch, sistema de tope de temperatura a 38°C y sistema de corte de seguridad.

Cool touch thermostatic round slide bar shower mixer kit, built-in diverter, flexible hose, ABS hand shower and round ABS overhead.

Colonne de douche extensible, avec mitigeur thermostatique cool touch, inverseur intégré, pomme de douche ronde, flexible et douchette 3 positions anti calcaire.

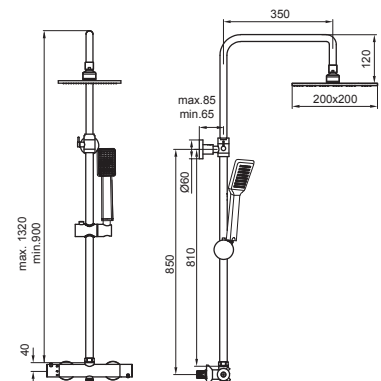
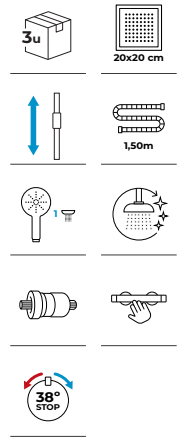

REFERENCIA PVP

44430/2 | 447,25 €

Termosol: Columna de ducha telescópica termostática con dos vías, inversor integrado, rociador INOX cuadrado, flexo y mango ducha ABS autoclean. Sistema cool touch, sistema de tope de temperatura.

Cool touch chrome thermostatic round slide bar shower mixer kit, built-in diverter, flexible hose, ABS hand shower and squared ABS overhead.

Colonne de douche extensible avec mitigeur thermostatique cool touch, inverseur intégré, pomme de douche carrée, flexible et douchette anti calcaire.

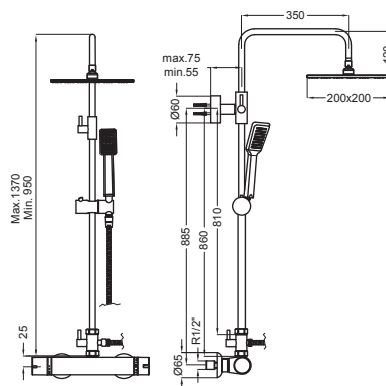

REFERENCIA PVP

35430/2 | 365,45 €

Termostar: Columna de ducha telescópica termostática con dos vías, inversor integrado, rociador INOX cuadrado, flexo y mango ducha ABS autoclean. Sistema de tope de temperatura a 38°C y sistema de corte de seguridad.

Thermostatic round slide bar shower mixer kit, with diverter, flexible hose, ABS hand shower and squared inox 3mm overhead.

Colonne de douche extensible avec mitigeur thermostatique, inverseur, pomme de douche carrée inox 3 mm, flexible et douchette carrée anti calcaire.

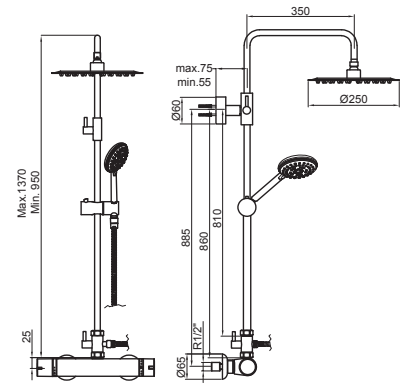

REFERENCIA PVP

35430/3 | 369,20 €

Termostar: Columna de ducha vista telescópica termostática con dos vías, inversor, rociador INOX redondo autoclean, flexo y mango ducha ABS. Sistema con tope temperatura a 38 °C y sistema corte de seguridad por fallos suministro..

Thermostatic round slide bar shower mixer kit, with diverter, flexible hose, ABS hand shower and round inox auto clean overhead.

Colonne de douche extensible avec mitigeur thermostatique, inverseur, pomme de douche ronde inox autoclean, flexible et douchette anti calcaire.

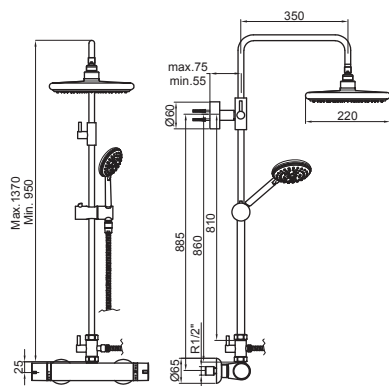
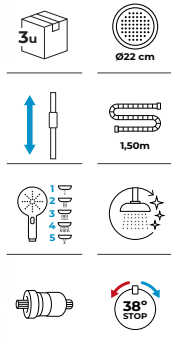

REFERENCIA PVP

35430/C | 304,17 €

Termostar: Columna de ducha vista telescópica termostática con dos vías, inversor, rociador ABS redondo 3 mm autoclean, flexo y mango ducha ABS autoclean. Sistema de tope de temperatura a 38°C y sistema de corte de seguridad.

Thermostatic round slide bar shower mixer kit, with diverter, flexible hose, ABS hand shower and round inox 3mm overhead.

Colonne de douche extensible avec mitigeur thermostatique, inverseur, pomme de douche ronde inox 3 mm, flexible et douchette anti calcaire.

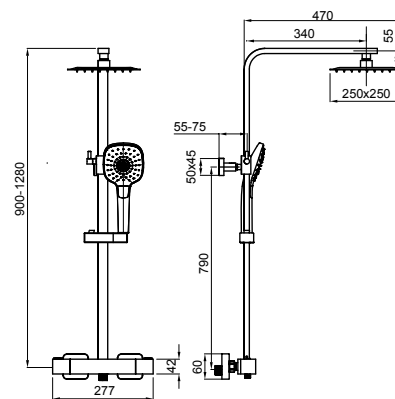
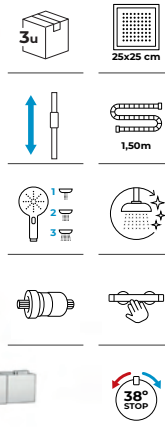

REFERENCIA PVP

48430 | 454,20 €

Termostyle: Columna de ducha telescópica termostática con dos vías, inversor integrado, flexo, rociador cuadrado inox y mango de ducha ABS autoclean. Sistema cool touch, sistema de tope de temperatura a 38°C y sistema de corte de seguridad.

Cool touch thermostatic round slide bar shower mixer kit, built-in diverter, flexible hose, ABS hand shower and inox squared overhead.

Colonne de douche extensible, avec mitigeur thermostatique cool touch, inverseur intégré, pomme de douche carrée inox, flexible et douchette anti calcaire carrée.

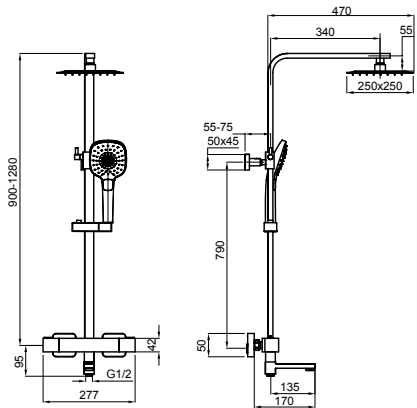
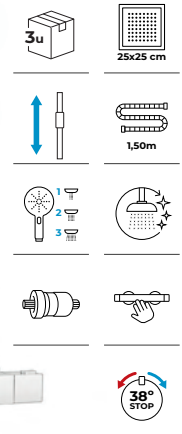

REFERENCIA PVP

48530 | 495,40 €

Termostyle: Columna de ducha telescópica termostática con tres vías, inversor integrado, caño, rociador cuadrado inox, flexo y mango de ducha ABS autoclean. Sistema cool touch, sistema de tope de temperatura a 38°C y sistema de corte de seguridad.

Cool touch thermostatic round slide bar shower mixer with spout, built-in diverter kit and with flexible hose, ABS hand shower and inox squared overhead.



Colonne de douche extensible avec mitigeur thermostatique cool touch, inverseur intégré, bec baignoire, pomme de douche carrée inox et douchette anti calcaire.

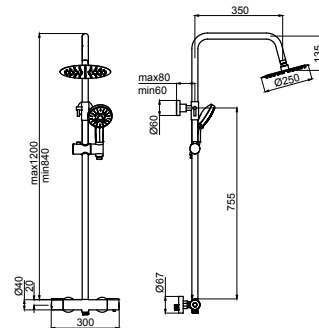

NOVEDAD



REFERENCIA PVP

-  51430 | 218,70 €
-  51430/N | 249,50 €

Termostop: Columna de ducha telescópica termostática de dos vías, con rociador INOX y mango de ducha en PVD anticalcáreo. Sistema cool touch, sistema de tope de temperatura a 38°C y sistema de corte de seguridad.

Two outlets thermostatic slide bar shower mixer with cool touch system, safety stop at 38°C and supply fail protection. With hose, ABS auto clean hand shower and round inox 3 mm Slim, ø 25 cm overhead.

Barre de douche extensible, mitigeur thermostatique, avec système cool touch, butée de confort à 38°C et protection contre les pannes d'alimentation. Pomme de douche ronde inox Slim ø 25 cm autoclean et douchette anti calcaire.

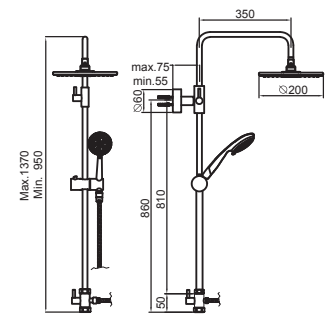

REFERENCIA PVP

-  4078/C | 200,85 €

Aura: Barra de ducha vista telescópica, con flexo, rociador redondo, flexo y mango ducha ABS autoclean.

Round slide bar shower kit, with ABS auto clean hand shower and ABS auto clean round overhead.

Barre de douche extensible avec pomme de douche ronde ABS autoclean et douchette ABS autoclean.

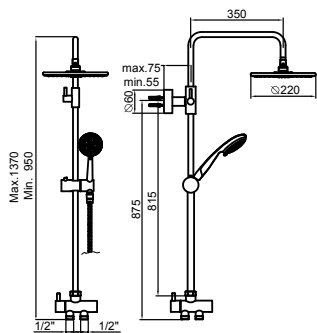
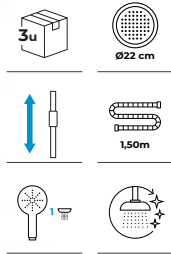

REFERENCIA PVP

4078/E | 214,80 €

Delta: Barra de ducha vista telescópica, distribuidor 2 posiciones, con flexo, rociador redondo y mango ducha ABS autoclean.

Round slide bar shower kit, with diverter, ABS auto clean hand shower and ABS auto clean round overhead.

Barre de douche extensible avec inverseur, pomme de douche ronde ABS autoclean et douchette ABS autoclean.

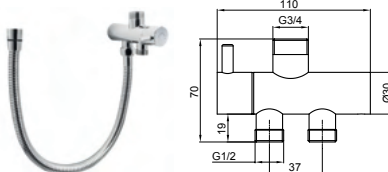

REFERENCIA PVP

4032 | 65,13 €

Enlace distribuidor para barra vista.
Connection distributor for shower column.
Connection distributeur pour barre de douche.

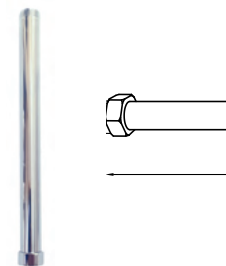

REFERENCIA PVP

004115 | 30,26 €

Prolongador para barra de ducha.
Shower bar extender.
Rallongeur pour barre de douche.

Colección TERMOSTÁTICAS



Equilibrio, precisión y confort definen nuestra colección de duchas termostáticas. Columnas y sistemas empotrados que garantizan una temperatura constante, con la máxima seguridad y fiabilidad. Una gama amplia de diseños y acabados que se adapta a todos los estilos de baño, ofreciendo una experiencia sensorial única.

Balance, precision, and comfort define our thermostatic shower collection. Columns and built-in systems that ensure a constant temperature with maximum safety and reliability. A wide range of designs and finishes adapts to every bathroom style, offering a unique sensory experience.

Équilibre, précision et confort définissent notre collection de douches thermostatiques. Colonnes et systèmes encastrés garantissant une température constante, avec une sécurité et une fiabilité maximales. Une large gamme de designs et de finitions s'adapte à tous les styles de salle de bains, offrant une expérience sensorielle unique.

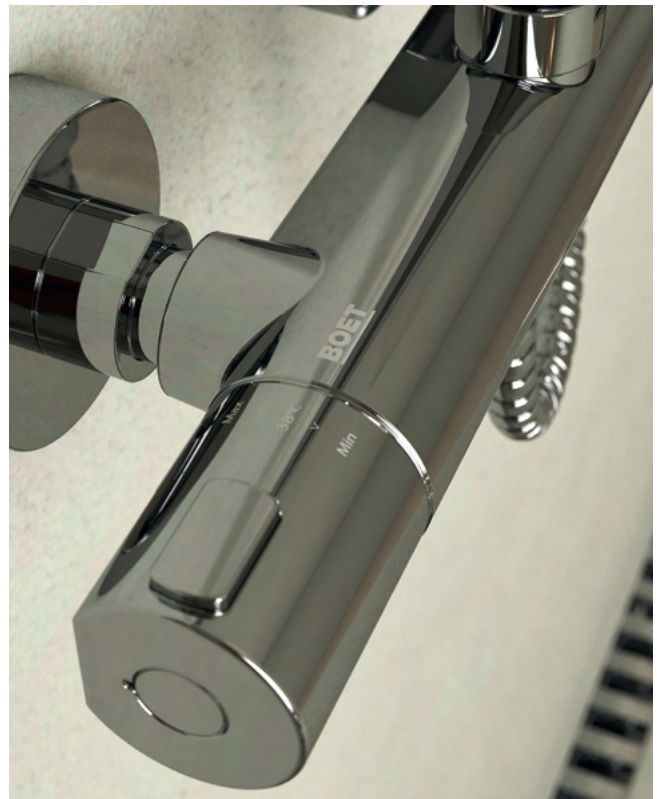



TERMOSTÁTICAS



Termosense: Grifería termostática empotrada de ducha con tres vías push, soporte integrado en la placa, flexo y mango de ducha ABS autoclean. Sistema de tope de temperatura a 38°C y sistema de corte de seguridad.

Built-in thermostatic shower mixer 3 ways push, with support integrated in the plate, hose and ABS hand shower.

Mitigeur à encastrer thermostatique de douche push avec 3 sorties et support intégré dans la plaque.

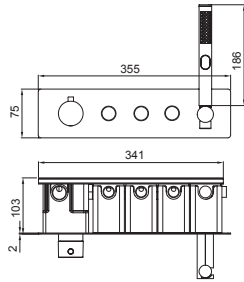

REFERENCIA	PVP
82149	700,84 €
82149/N	766,74 €
82149/NQ	946,49 €
82149/G	946,49 €
82149/BC	987,68 €

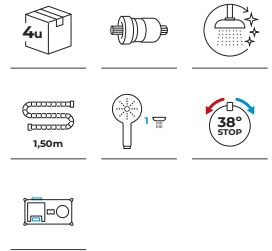

Termosense: Grifería termostática empotrada de ducha con dos vías push, soporte integrado en la placa, flexo y mango de ducha ABS autoclean. Sistema de tope de temperatura a 38°C y sistema de corte de seguridad.

Built-in thermostatic shower mixer 2 ways push, with support integrated in the plate, hose and ABS hand shower.

Mitigeur à encastrer thermostatique de douche push avec 2 sorties et support intégré dans la plaque.

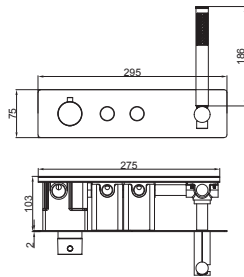

REFERENCIA	PVP
82148	603,79 €
82148/N	664,17 €
82148/NQ	835,78 €
82148/G	835,78 €
82148/BC	877,00 €

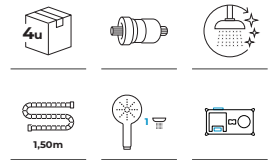

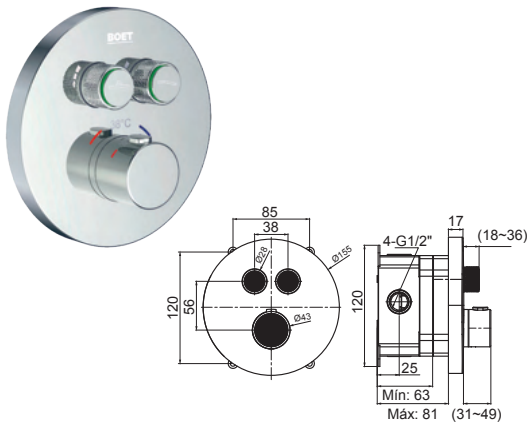

Termolux: Grifería termostática empotrada de ducha con dos vías de caudal regulable, sistema de tope de temperatura a 38°C y sistema de corte de seguridad.

Concealed thermostatic shower mixer with two adjustable flow outlets, 38°C temperature limit stop system and safety shut-off system.

Robinetterie thermostatique de douche encastrée avec deux voies à débit réglable, système de butée de température à 38 °C et système de coupure de sécurité.



REFERENCIA	PVP
52148	287,67 €
52148/N	299,45 €
52148/G	354,64 €
52148/RG	385,35 €



Termolux: Grifería termostática empotrada de ducha con dos vías de caudal regulable, sistema de tope de temperatura a 38°C y sistema de corte de seguridad, rociador con brazo de pared, flexo, soporte y mango de ducha.

Concealed thermostatic shower mixer with two adjustable flow outlets, 38°C temperature limit stop system and safety shut-off system, overhead shower with wall-mounted arm, hose, holder and hand shower.

Robinetterie thermostatique de douche encastrée avec deux voies à débit réglable, système de butée de température à 38 °C et système de coupure de sécurité, pomme de tête avec bras mural, flexible, support et douchette.



REFERENCIA	PVP
Pack 52148/1	378,13 €
Pack 52148/1/N	437,68 €
Pack 52148/1/G	536,14 €
Pack 52148/1/RG	585,40 €



Termolux: Grifería termostática empotrada de ducha con dos vías de caudal regulable, sistema de tope de temperatura a 38°C y sistema de corte de seguridad, rociador con brazo de techo, flexo, soporte y mango de ducha.

Concealed thermostatic shower mixer with two adjustable flow outlets, 38°C temperature limit stop system and safety shut-off system, overhead shower with ceiling-mounted arm, hose, holder and hand shower.

Robinetterie thermostatique de douche encastrée avec deux voies à débit réglable, système de butée de température à 38 °C et système de coupure de sécurité, pomme de tête avec bras plafond, flexible, support et douchette.



REFERENCIA	PVP
Pack 52148/2	378,13 €
Pack 52148/2/N	437,68 €
Pack 52148/2/G	536,14 €
Pack 52148/2/RG	585,40 €

TERMOSTÁTICAS

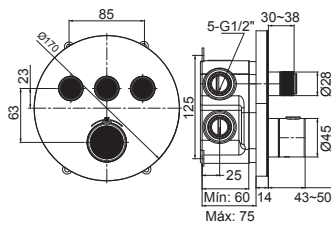

Termolux: Grifería termostática empotrada de ducha con tres vías de caudal regulable, sistema de tope de temperatura a 38° y sistema de corte de seguridad.

Concealed thermostatic shower mixer with three adjustable flow outlets, 38°C temperature limit stop system and safety shut-off system.

Robinetterie thermostatique de douche encastrée avec trois voies à débit réglable, système de butée de température à 38 °C et système de coupure de sécurité.



REFERENCIA	PVP
------------	-----

52149	370,30 €
52149/N	379,96 €
52149/G	703,56 €
52149/RG	710,94 €



Termolux: Grifería termostática empotrada de ducha con dos vías de caudal regulable, sistema de tope de temperatura a 38°C y sistema de corte de seguridad, rociador con brazo de pared, flexo, soporte con mango de ducha y caño de bañera.

Concealed thermostatic shower mixer with two adjustable flow outlets, 38°C temperature limit stop system and safety shut-off system, overhead shower with wall-mounted arm, hose, holder with hand shower and bath spout.

Robinetterie thermostatique de douche encastrée avec deux voies à débit réglable, système de butée de température à 38 °C et système de coupure de sécurité, pomme de tête avec bras mural, flexible, support avec douchette et bec de baignoire.



REFERENCIA	PVP
------------	-----

Pack 52149/1	460,76 €
Pack 52149/1/N	518,19 €
Pack 52149/1/G	671,80 €
Pack 52149/1/RG	681,30 €



Termolux: Grifería termostática empotrada de ducha con dos vías de caudal regulable, sistema de tope de temperatura a 38°C y sistema de corte de seguridad, rociador con brazo de techo, flexo, soporte con mango de ducha y caño de bañera.

Concealed thermostatic shower mixer with two adjustable flow outlets, 38°C temperature limit stop system and safety shut-off system, overhead shower with ceiling-mounted arm, hose, holder with hand shower and bath spout.

Robinetterie thermostatique de douche encastrée avec deux voies à débit réglable, système de butée de température à 38 °C et système de coupure de sécurité, pomme de tête avec bras plafond, flexible, support avec douchette et bec de baignoire.



REFERENCIA	PVP
------------	-----

Pack 52149/2	460,76 €
Pack 52149/2/N	518,19 €
Pack 52149/2/G	671,80 €
Pack 52149/2/RG	681,30 €

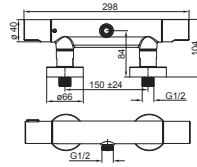

Moon: Mezclador termostático para ducha con sistema cool touch, sistema de tope de temperatura a 38°C y sistema de corte de seguridad.

Thermostatic shower mixer with cool touch system, safety stop at 38°C and supply fail protection. without accessories.

Mitigeur thermostatique pour douche avec système cool touch, butée de confort à 38°C et protection contre les pannes d'alimentation. Sans accessoires.

REFERENCIA PVP

44424 | 184,02 €

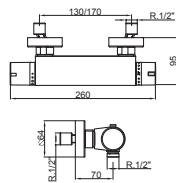
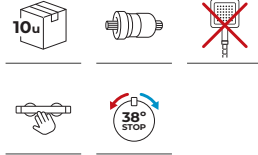

Termostar: Grifo de ducha termostático con sistema de tope de temperatura a 38°C y sistema de corte de seguridad.

Thermostatic shower mixer with 38°C safety stop and safety shut-off system.

Mitigeur de douche thermostatique avec butée de sécurité à 38 °C et système d'arrêt de sécurité.

REFERENCIA PVP

35424 | 149,77 €

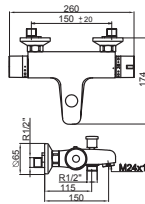
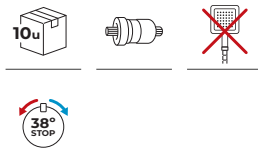

Termostar: Grifo baño-ducha termostático con inversor automático, sistema de tope de temperatura a 38°C y sistema de corte de seguridad.

Thermostatic bath-shower mixer with cool touch system, safety stop at 38°C and supply fail protection.

Mitigeur bain douche thermostatique avec limiteur de température à 38°C et système d'arrêt de sécurité.

REFERENCIA PVP

35555 | 243,23 €

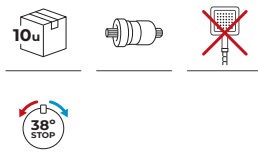

TERMOSTÁTICAS

TERMOSTÁTICAS

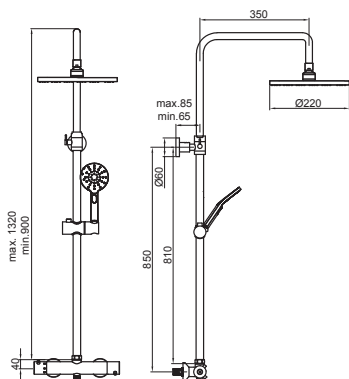
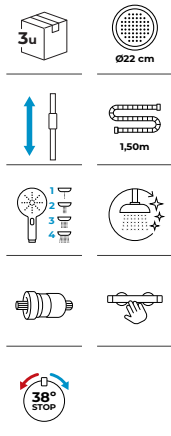

REFERENCIA **PVP**

44430 351,31 €

Termosol: Columna de ducha telescópica termostática con dos vías, inversor integrado, rociador ABS redondo, flexo y mango de ducha ABS autoclean. Sistema cool touch, sistema de tope de temperatura a 38°C y sistema de corte de seguridad.

Cool touch thermostatic round slide bar shower mixer kit, built-in diverter, flexible hose, ABS hand shower and round ABS overhead.

Colonne de douche extensible avec mitigeur thermostatique cool touch, inverseur intégré, pomme de douche ronde, flexible et douchette 3 positions anti calcaire.

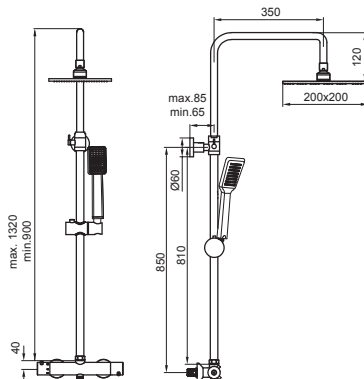
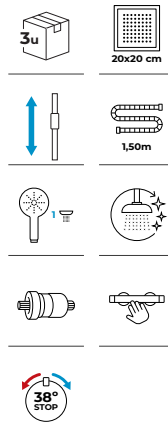
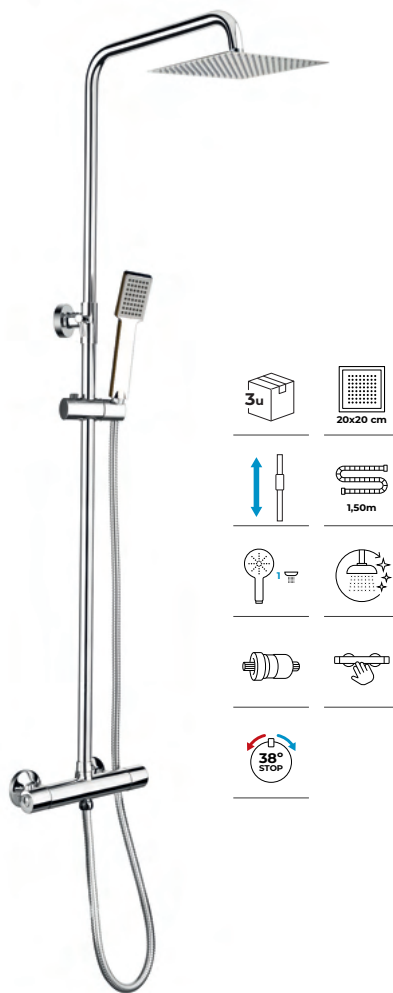

REFERENCIA **PVP**

44430/2 447,25 €

Termosol: Columna de ducha telescópica termostática con dos vías, inversor integrado, rociador INOX cuadrado, flexo y mango ducha ABS autoclean. Sistema cool touch, sistema de tope de temperatura a 38°C y sistema de corte de seguridad.

Cool touch chrome thermostatic round slide bar shower mixer kit, built-in diverter, flexible hose, ABS hand shower and squared ABS overhead.

Colonne de douche extensible avec mitigeur thermostatique cool touch, inverseur intégré, pomme de douche carrée, flexible et douchette carrée anti calcaire.

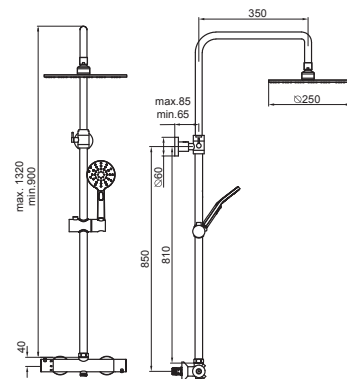
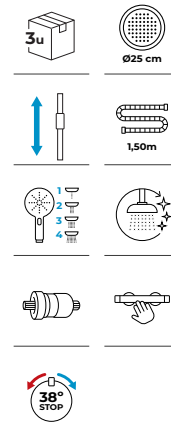

REFERENCIA **PVP**

44430/3 442,95 €

Termosol: columna de ducha telescópica termostática con dos vías, inversor integrado, rociador inox redondo 3 mm, flexo y mango de ducha ABS autoclean. Sistema cool touch, sistema de tope de temperatura a 38°C y sistema de corte de seguridad.

Cool touch thermostatic round slide bar shower mixer kit, built-in diverter, flexible hose, ABS hand shower and round inox 3mm overhead.

Colonne de douche extensible avec mitigeur thermostatique cool touch, inverseur intégré, pomme de douche ronde inox 3 mm, flexible et douchette 3 positions anti calcaire.

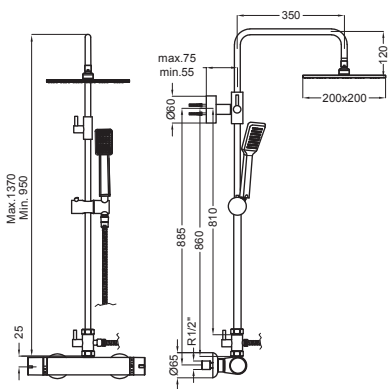
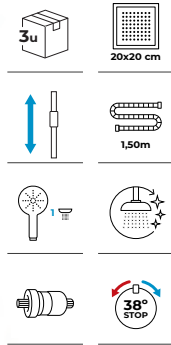
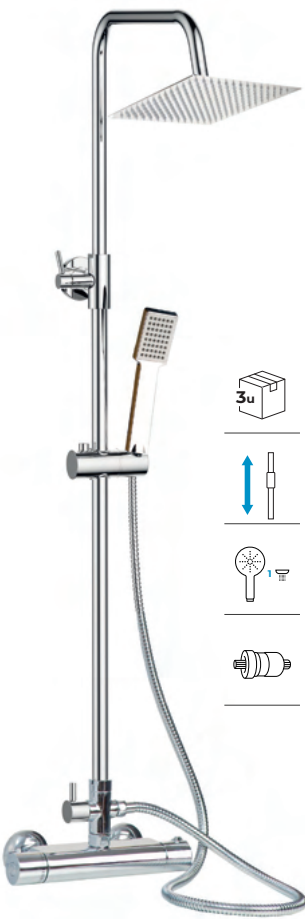

REFERENCIA PVP

35430/2 | 365,45 €

Termostar: Columna de ducha telescópica termostática con dos vías, inversor integrado, rociador INOX cuadrado, flexo y mango ducha ABS autoclean. Sistema de tope de temperatura a 38°C y sistema de corte de seguridad.

Thermostatic round slide bar shower mixer kit, with diverter, flexible hose, ABS hand shower and squared inox 3mm overhead.

Colonne de douche extensible avec mitigeur thermostatique, inverseur, pomme de douche carrée inox 3 mm, flexible et douchette carrée anti calcaire.

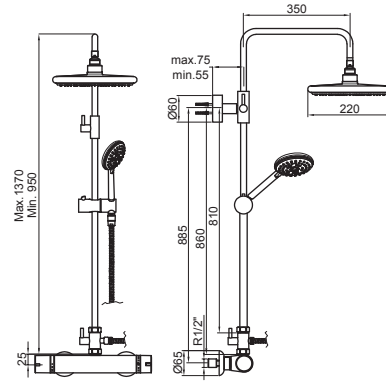
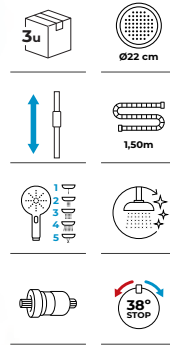
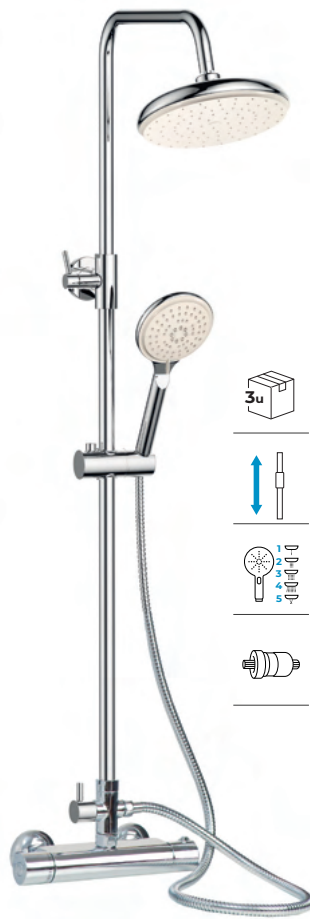

REFERENCIA PVP

35430/C | 304,17 €

Termostar: Columna de ducha vista telescópica termostática con dos vías, inversor, rociador ABS redondo autoclean, flexo y mango ducha ABS autoclean. Sistema de tope de temperatura a 38°C y sistema de corte de seguridad.

Thermostatic round slide bar shower mixer kit, with diverter, flexible hose, ABS hand shower and round ABS overhead.

Colonne de douche extensible avec mitigeur thermostatique, inverseur, pomme de douche ronde ABS, flexible et douchette anti calcaire.

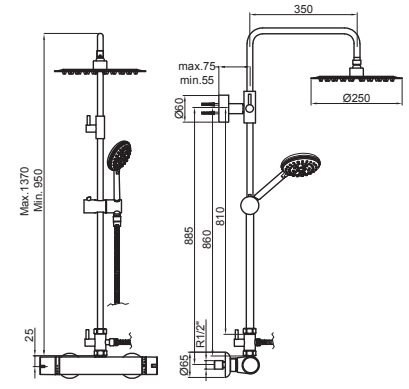
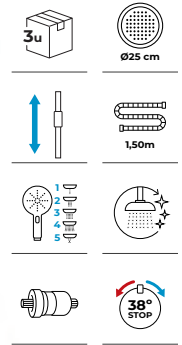
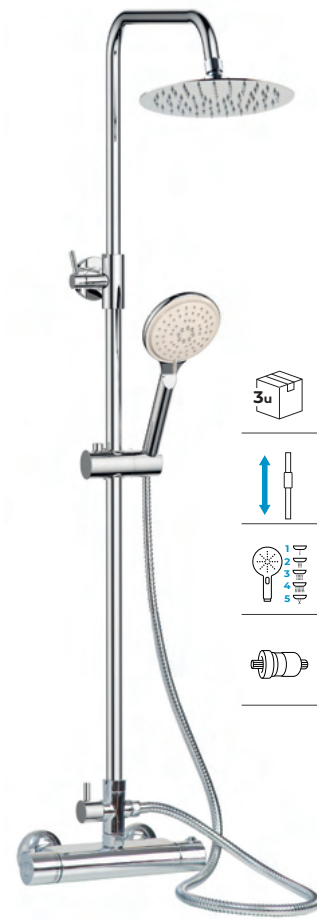

REFERENCIA PVP

35430/3 | 369,20 €

Termostar: Columna de ducha vista telescópica termostática con dos vías, inversor, rociador INOX redondo autoclean, flexo y mango ducha ABS. Sistema con tope temperatura a 38 °C y sistema corte de seguridad por fallos suministro..

Thermostatic round slide bar shower mixer kit, with diverter, flexible hose, ABS hand shower and round inox abs auto clean overhead.

Colonne de douche extensible avec mitigeur thermostatique, inverseur, pomme de douche ronde inox autoclean, flexible et douchette anti calcaire.

TERMOSTÁTICAS

TERMOSTÁTICAS

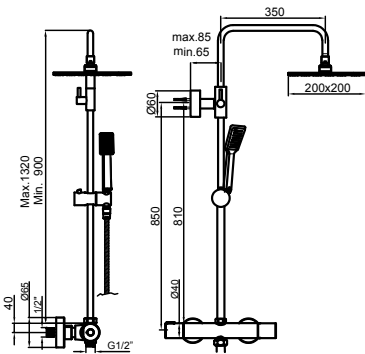
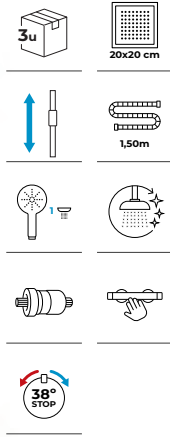

REFERENCIA PVP

44431/2 | 338,25 €

Termoline: Columna de ducha telescópica termostática con dos vías, con flexo, rociador y mango de ducha cuadrados. Sistema cool touch, sistema de tope de temperatura a 38°C y sistema de corte de seguridad.

Shower 2 ways (squared overhead and hand shower) slide bar. Thermostatic shower mixer with cool touch system, safety stop at 38°C and supply fail protection.

Colonne de douche thermostatique télescopique à deux sorties avec pommeau rond en acier inoxydable, flexible et douchette. Système Cool Touch, limiteur de température à 38 °C et système d'arrêt de sécurité.

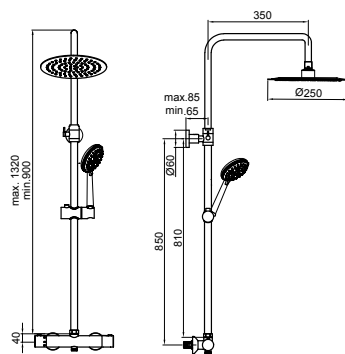
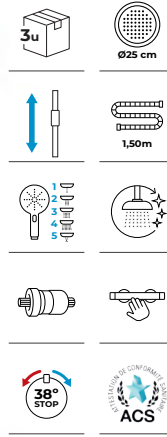

REFERENCIA PVP

44431 | 334,39 €
 44431/N | 487,33 €
 44431/NQ | 529,50 €
 44431/G | 529,35 €
 44431/BC | 615,89 €
 44431/RG | 585,42 €

Termoline: Columna de ducha vista telescópica termostática de dos vías, rociador redondo INOX, flexo y mango de ducha autoclean. Sistema cool touch, sistema de tope de temperatura a 38°C y sistema de corte de seguridad.

Telescopic thermostatic shower column with two outlets, round INOX shower head, flexible hose and autoclean hand shower. Cool touch system, 38°C safety stop and safety shut-off system.

Colonne de douche thermostatique télescopique à deux sorties avec pommeau rond en acier inoxydable, flexible et douchette. Système Cool Touch, limiteur de température à 38 °C et système d'arrêt de sécurité.

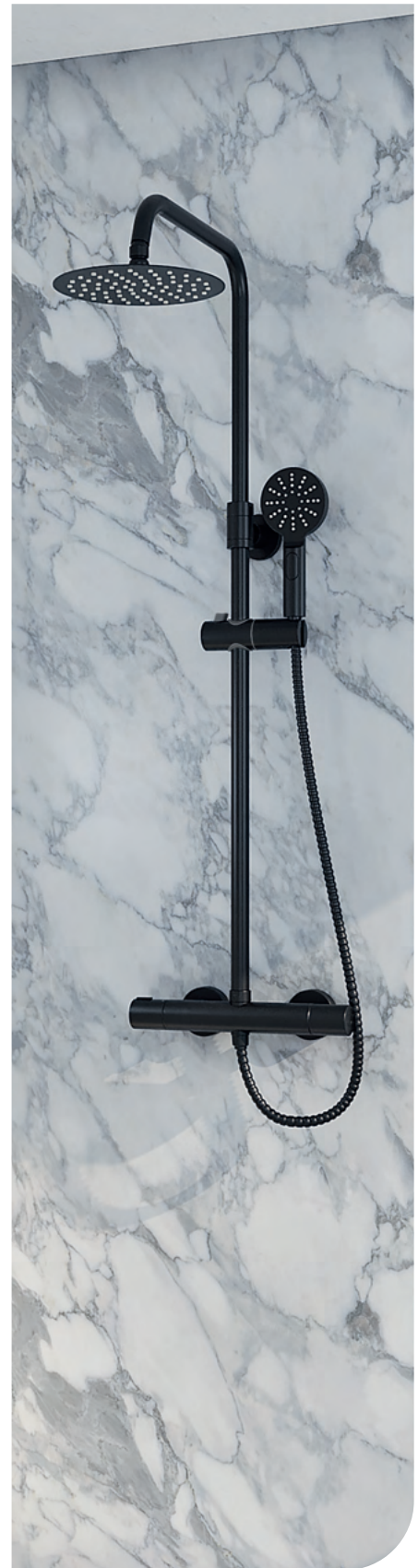

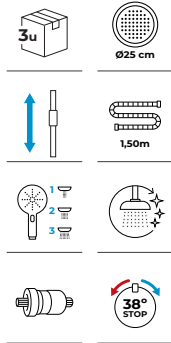

NOVEDAD

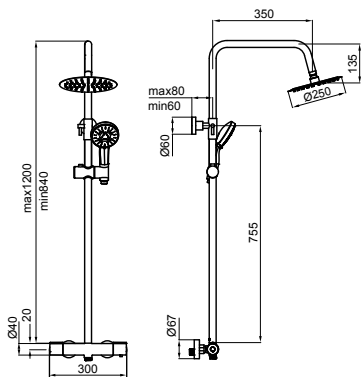

REFERENCIA PVP

- 51430 | 218,70 €
- 51430/N | 249,50 €

Termoplus: Columna de ducha telescópica termostática de dos vías, con rociador INOX y mango de ducha en PVD anticálcero. Sistema de tope de temperatura a 38°C y sistema de corte de seguridad.

Two outlets thermostatic slide bar shower mixer with safety stop at 38°C and supply fail protection. With hose, ABS auto clean hand shower and round inox 3 mm Slim, Ø 25 cm overhead.

Barre de douche extensible, mitigeur thermostatique, avec butée de confort à 38°C et protection contre les pannes d'alimentation. Pomme de douche ronde inox Slim Ø 25 cm autoclean et douchette anti calcaire.

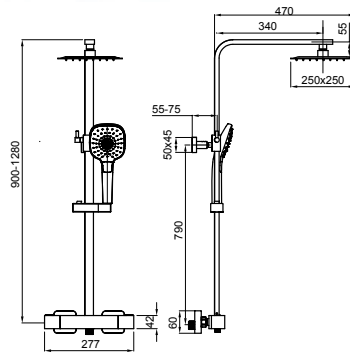
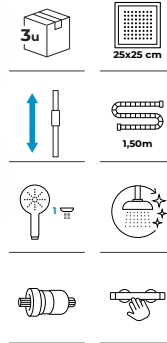

REFERENCIA PVP

- 48430 | 454,20 €

Termostyle: Columna de ducha telescópica termostática con dos vías, inversor integrado, flexo, rociador cuadrado inox y mango de ducha ABS autoclean. Sistema cool touch, sistema de tope de temperatura a 38°C y sistema de corte de seguridad.

Cool touch thermostatic round slide bar shower mixer kit, built-in diverter, flexible hose, ABS hand shower and inox squared overhead.

Colonne de douche extensible, avec mitigeur thermostatique cool touch, inverseur intégré, bec baignoire, pomme de douche carrée inox, flexible et douchette anti calcaire.

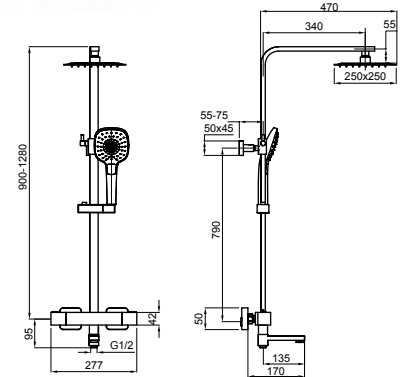
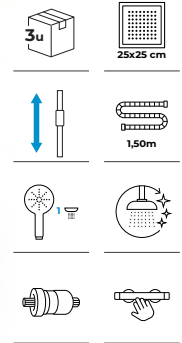

REFERENCIA PVP

- 48530 | 495,40 €

Termostyle: Columna de ducha telescópica termostática con tres vías, inversor integrado, caño, rociador cuadrado inox, flexo y mango de ducha ABS autoclean. Sistema cool touch, sistema de tope de temperatura a 38°C y sistema de corte de seguridad.

Cool touch thermostatic round slide bar shower mixer with spout, built-in diverter kit and with flexible hose, ABS hand shower and inox squared overhead.

Colonne de douche extensible avec mitigeur thermostatique cool touch, inverseur intégré, bec baignoire, pomme de douche carrée inox et douchette anti calcaire.

BOET BIMANDO

*Two-handle
Bimando*



La gama bimando de Boet reúne cinco colecciones que interpretan la grifería tradicional desde una mirada actual. Diseños que dialogan entre lo vintage, lo clásico, lo retro y lo contemporáneo, con una estética cuidada y atemporal. Piezas pensadas para proyectos que buscan personalidad, equilibrio y detalle. Diseño y precisión se unen en esta selección, con el sello de calidad Boet.

Boet's two-handle range brings together five collections that reinterpret traditional tapware through a contemporary lens. Designs that move between vintage, classic, retro and modern styles, with a refined and timeless aesthetic. Pieces created for projects seeking character, balance and attention to detail. Design and precision come together in this selection, bearing the Boet seal of quality.

La gamme bimando de Boet réunit cinq collections qui réinterprètent la robinetterie traditionnelle avec un regard contemporain. Des designs qui dialoguent entre le vintage, le classique, le rétro et le contemporain, dans une esthétique soignée et intemporelle. Des pièces pensées pour des projets en quête de personnalité, d'équilibre et de sens du détail. Le design et la précision s'unissent dans cette sélection, signée par la qualité Boet.

Índice bimandos.

Index.
Indice.



Terra 166



Classic 168



Antique 170



Verona 172



Pisa 176

BIMANDO

Colección TERRA



La colección Terra fusiona con maestría un diseño clásico con líneas modernas, con un resultado elegante y minimalista. Incorpora montura cerámica de 1/2 de vuelta. Acabados en cromo.

The Terra collection masterfully combines a classic design with modern lines, achieving an elegant and minimalist result. Equipped with 1/2-turn ceramic headwork. Chrome finish.

La collection Terra fusionne avec maîtrise un design classique et des lignes modernes, avec un résultat élégant et minimaliste. Équipée d'une tête céramique à 1/2 tour. Finition chrome.



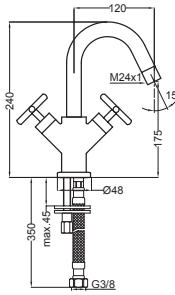

Mezclador bimando lavabo con montura cerámica 1/2" vuelta.
Twin-lever basin mixer.
Mélangeur lavabo.



REFERENCIA PVP

74107 | 239,75 €

REFERENCIA PVP

74108 | 252,32 €

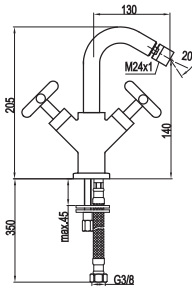

Mezclador bimando bidé con montura cerámica 1/2" vuelta.
Twin-lever bidet mixer.
Mélangeur bidet.



REFERENCIA PVP

74227 | 235,93 €

REFERENCIA PVP

74228 | 252,32 €

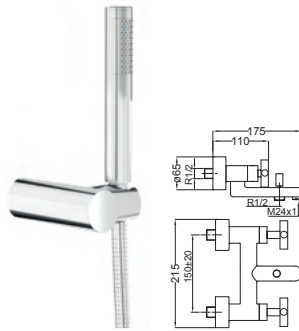

Mezclador bimando baño-ducha con inversor automático, flexo, soporte orientable y mango de ducha autoclean. Montura cerámica 1/2" vuelta.
Twin-lever bath-shower mixer, with flexible, automatic diverter and anti-limescale shower handset.
Mélangeur bain-douche avec flexible, inverseur automatique et douchette anti calcaire. Support orientable.

REFERENCIA PVP

74555 | 391,62 €

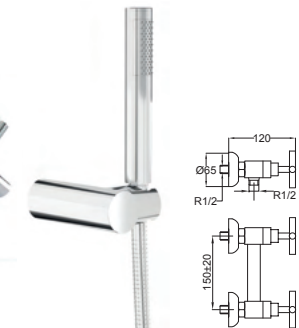

Mezclador bimando ducha con flexo, soporte orientable y mango de ducha autoclean. Montura cerámica 1/2" vuelta.
Twin-lever shower mixer with orientable support, flexible and anti-limescale shower handset.
Mélangeur douche avec flexible et douchette anti calcaire. Support orientable.

REFERENCIA PVP

74424 | 276,84 €

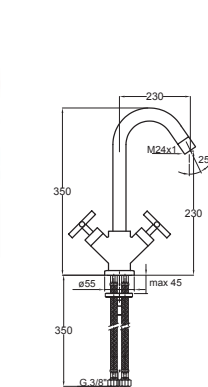

Mezclador bimando fregadero con caño giratorio cuello de cisne. Montura cerámica 1/2" vuelta.
Twin-lever kitchen mixer with swan neck swivel spout.
Mélangeur évier, bec de cygne pivotant.



REFERENCIA PVP

74657/11 | 239,93 €

Colección CLASSIC



Grifería de estilo clásico, con piezas de doble mando, destaca por sus suaves curvas y ondulaciones voluptuosas. Con acabados en cromo y monturas cerámicas de 1/4" de vuelta.

Classic-style taps with dual handles, featuring soft curves and voluptuous contours. Chrome finish and 1/4" turn ceramic headworks.

Robinetterie de style classique à double commande, caractérisée par des courbes douces et des ondulations voluptueuses. Finition chromée et têtes céramiques à 1/4" de tour.



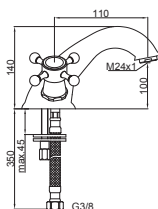

Mezclador bimando lavabo.
Montura cerámica 1/4" vuelta.
Twin-lever basin mixer.
Mélangeur lavabo.

REFERENCIA PVP



75147

168,17 €

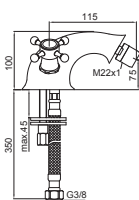

Mezclador bimando bidé.
Montura cerámica 1/4" vuelta.
Twin-lever bidet mixer.
Mélangeur bidet.

REFERENCIA PVP



75247

163,92 €

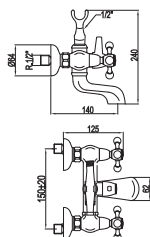

Mezclador bimando baño-ducha, inversor manual, flexo, soporte orientable, mango de ducha ABS autoclean. Montura cerámica 1/4" vuelta.
Twin-lever bath-shower mixer, with flexible, automatic diverter and anti-limescale shower handset.

Mélangeur bain-douche. Flexible, inverseur automatique, douchette anti calcaire. Support orientable.

REFERENCIA PVP



75556

308,22 €

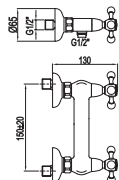

Mezclador bimando ducha, flexo, soporte orientable, mango de ducha ABS autoclean. Montura cerámica 1/4" vuelta.
Twin-lever shower mixer, with flexible and anti-limescale shower handset.

Mélangeur douche. Flexible, douchette anti calcaire. Support orientable.

REFERENCIA PVP



75426

172,13 €

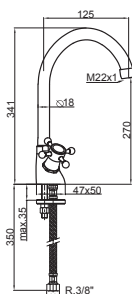

Mezclador bimando fregadero con caño giratorio cuello de cisne.
Montura cerámica 1/4" vuelta.
Twin-lever kitchen mixer with swan neck swivel spout.

Mélangeur évier avec bec de cygne pivotant.

REFERENCIA PVP



75656

134,58 €



Colección ANTIQUE



Diseño clásico de formas voluptuosas, con detalles discretamente modernos y acabados en cromo. Colección equipada con monturas cerámicas de 1/2 de vuelta que proporcionan un control preciso de la temperatura y presión.

Classic design with voluptuous shapes, subtly modern details and chrome finish. Collection equipped with 1/2 turn ceramic headworks providing precise control of flow and temperature.

Design classique aux formes voluptueuses, avec des détails subtilement modernes et finition chromée. Collection équipée de têtes céramiques à 1/2 tour offrant un contrôle précis du débit et de la température.



Colección VERONA



Diseño monobloc con elegantes acabados cromados, resalta por su robustez y estética atemporal. Equipada con montura cerámica de 1/2" de vuelta. Acabados en cromo. Amplio surtido de fregaderas de cocina y lavadora.

Monobloc design with elegant chrome finishes, standing out for its robustness and timeless aesthetics. Equipped with 1/2-turn ceramic headwork. Chrome finish. Wide range of kitchen and washing machine taps.

Design monobloc avec d'élégantes finitions chromées, se distinguant par sa robustesse et son esthétique intemporelle. Équipée d'une tête céramique à 1/2 tour. Finition chrome. Large gamme de robinets pour évier de cuisine et lave-linge.



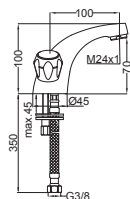

Mezclador bimando lavabo, rosca 1/2".
Twin-lever basin mixer.
Mélangeur lavabo.



REFERENCIA PVP

73107 | 67,19 €

REFERENCIA PVP

73108 | 89,71 €

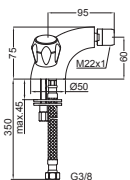

Mezclador bimando para bidé. Rosca 1/2".
Twin-lever bidet mixer.
Mélangeur bidet.



REFERENCIA PVP

73227 | 67,19 €

REFERENCIA PVP

73228 | 89,71 €

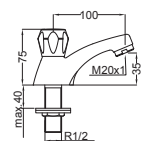

Grifo de repisa para lavabo 1 agua con atomizador.
Rosca 1/2".
1 outlet basin tap.
Robinet lave-mains lavabo.



REFERENCIA PVP

73101 | 33,58 €

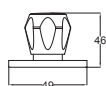

Grifo integral 1 agua para bidé.
1 outlet bidet mixer.
Robinet pour bidet.



REFERENCIA PVP

73201 | 31,48 €

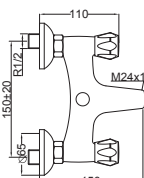

Mezclador bimando baño-ducha con inversor automático, flexo, soporte orientable, mango de ducha autoclean.
Rosca 1/2".
Twin-lever bath-shower mixer, with flexible, automatic diverter and anti-limescale shower handset.

Mélangeur bain-douche avec flexible, inverseur automatique, et douchette anti calcaire. Support orientable.



REFERENCIA PVP

73555 | 86,96 €



REFERENCIA PVP

73555/0 | 80,13 €





Mezclador bimando ducha con flexo, soporte orientable y mango de ducha autoclean. Rosca 1/2".

Twin-lever shower mixer, with flexible and anti-limescale shower handset.

Mélangeur douche avec flexible, douchette anti calcaire et support orientable.



REFERENCIA PVP

73424 | 77,90 €



REFERENCIA PVP

73424/0 | 72,19 €



Mezclador bimando fregadero, caño giratorio alto. Rosca 1/2".

Twin-lever kitchen mixer, swivel spout.

Mélangeur évier, bec pivotant.

REFERENCIA PVP

73657/11 | 67,07 €

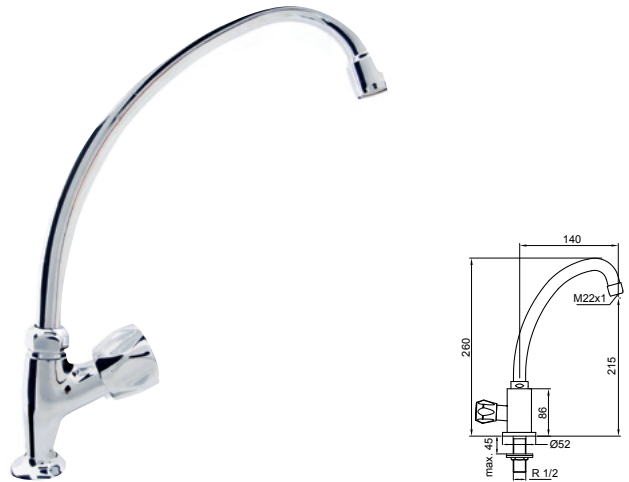

Grifo mural para fregadero 1 agua, con caño giratorio cuello de cisne. Rosca 1/2".

Kitchen faucet, swan neck swivel spout.

Robinet évier avec bec de cygne pivotant.

REFERENCIA PVP

73620/11 | 39,16 €

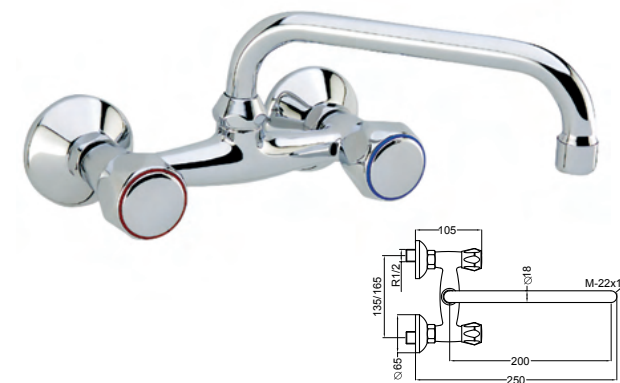

Mezclador bimando para fregadero, con caño giratorio bajo de 200 mm. Instalación mural con entre ejes de 150 mm.

Twin-lever kitchen mixer, 200 mm swivel U spout.

Mélangeur évier, bec bas pivotant de 200 mm.

REFERENCIA PVP

73631/60 | 69,09 €

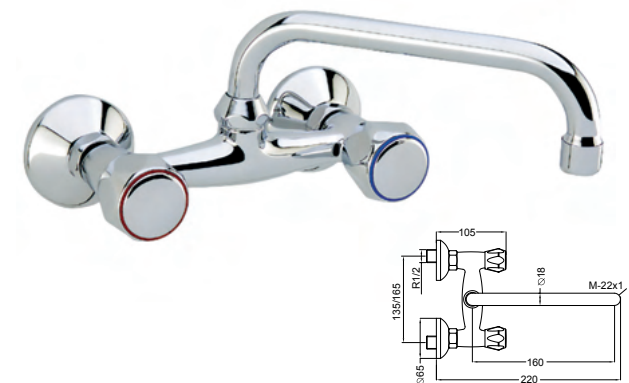

Mezclador bimando para fregadero con caño giratorio bajo de 160 mm. Instalación mural con entre ejes de 150 mm

Twin-lever kitchen mixer, 160 mm swivel U spout.

Mélangeur évier avec bec bas pivotant de 160 mm.

REFERENCIA PVP

73631/58 | 69,09 €



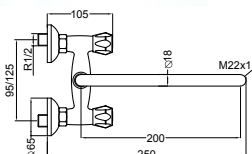

Mezclador bimando para fregadero con caño giratorio bajo de 200 mm. Instalación mural con entre ejes de 100 mm.

Twin-lever kitchen mixer, 200 mm swivel U spout.

Mélangeur évier, bec bas pivotant de 200 mm.

REFERENCIA PVP



73624/60

69,09 €

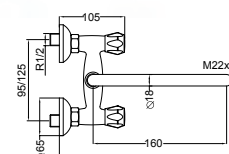

Mezclador bimando para fregadero con caño giratorio bajo de 160 mm. Instalación mural con entre ejes de 100 mm.

Twin-lever kitchen mixer, 160 mm swivel U spout.

Mélangeur évier, bec bas pivotant de 160 mm.

REFERENCIA PVP



73624/58

69,09 €

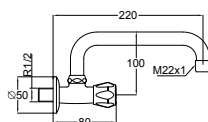

Grifo mural para fregadero 1 agua, con caño giratorio en U. Rosca 1/2".

Kitchen faucet swivel spout.

Robinet évier, bec pivotant en U.

REFERENCIA PVP



73609/60

31,05 €

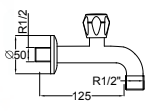

Grifo mural para lavadero, 1 agua. Rosca 1/2".

Wall mounted faucet.

Robinet encastrable.

REFERENCIA PVP



73602

27,47 €

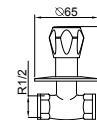

Llave de paso empotrada. Rosca 1/2".

Wall mounted stop tap 1/2".

Robinet d'arrêt encastrable 1/2".

REFERENCIA PVP



73702

21,84 €

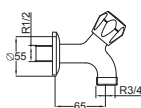

Grifo de lavadora 1/2", salida 3/4".

Mixer for washing machine, 1/2", exit 3/4".

Robinet pour machine à laver 1/2", sortie 3/4".

REFERENCIA PVP



73004

21,86 €

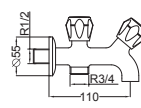

Grifo para lavadora doble, 1 agua. Rosca 1/2".

Double mixer for washing machine 1/2".

Robinet double pour machine à laver 1/2".

REFERENCIA PVP



73614

39,51 €

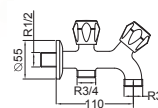

Grifo para lavadora doble, 1 agua. Rosca 3/4".

Double mixer for washing machine 3/4".

Robinet double pour machine à laver 3/4".

REFERENCIA PVP



73617

39,51 €



Colección PISA



Grifería bimando de diseño sóbrio y honesto, equipada con montura cerámica de 1/4 de vuelta, creada para durar. Incorpora una amplia colección de grifos de cocina. Acabados en cromo.

Two-handle tapware with a sober and genuine design, equipped with 1/4-turn ceramic headwork, built to last. Includes a wide range of kitchen taps. Chrome finish.

Robinetterie à deux poignées au design sobre et authentique, équipée de têtes céramiques 1/4 de tour, conçue pour durer. Comprend une large gamme de robinets de cuisine. Finition chromée.



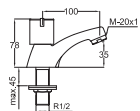

Grifo de repisa monobloc para lavabo con 1 vía. Montura cerámica 1/4" vuelta.

Single tap for wash basin.

Robinet pour lavabo.



REFERENCIA PVP



78101

33,58 €

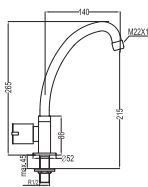

Grifo monobloc para fregadero con caño giratorio. Montura cerámica 1/4" vuelta.

Kitchen faucet, swan neck swivel spout.

Robinet évier, bec de cygne pivotant.



REFERENCIA PVP



78620/11

39,16 €

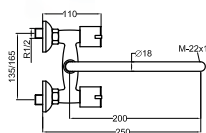

Grifo monobloc para fregadero a pared, caño giratorio bajo de 20 cm. Montura cerámica 1/4" vuelta.

Twin-lever kitchen mixer, 20 cm swivel U spout.

Mélangeur évier, bec bas pivotant de 20 cm.



REFERENCIA PVP



78631/60

69,09 €

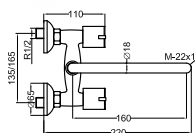

Grifo monobloc para fregadero a pared, caño giratorio bajo de 16 cm. Montura cerámica 1/4" vuelta.

Twin-lever kitchen mixer, 16 cm swivel U spout.

Mélangeur évier, bec bas pivotant de 16 cm.



REFERENCIA PVP



78631/58

69,09 €



Grifo monobloc para fregadero a pared, caño giratorio bajo de 20 cm. Montura cerámica 1/4" vuelta.

Twin-lever kitchen mixer, 20 cm swivel U spout.

Mélangeur évier, bec bas pivotant de 20 cm.



REFERENCIA	PVP
78624/60	69,09 €



Grifo monobloc para fregadero a pared, caño giratorio bajo de 16 cm. Montura cerámica 1/4" vuelta.

Twin-lever kitchen mixer, 16 cm swivel U spout.

Mélangeur évier, bec bas pivotant de 16 cm.



REFERENCIA	PVP
78624/58	69,09 €



Grifo monobloc con 1 vía para fregadero a pared con caño giratorio en U. Montura cerámica 1/4" vuelta.

Kitchen faucet swivel spout.

Robinet évier, bec pivotant en U.



REFERENCIA	PVP
78609/60	31,05 €



Grifo monobloc fregadero a pared con 1 vía. Montura cerámica 1/4" vuelta.

Wall mounted faucet with aerator.

Robinet mural avec aérateur.



REFERENCIA	PVP
78602	27,47 €

Producto Relacionado



Ref. 91056F

Sifón de latón cilíndrico.

Brass siphon.

Siphon laiton.



BIMANDO
Pisa

BOET

COLECTIVIDADES

Public Sector

Collectivités



Nuestra gama para Colectividades reúne cuatro colecciones diseñadas para responder a las exigencias de los espacios de uso intensivo. Soluciones que combinan eficiencia, seguridad y durabilidad en entornos públicos y colectivos. Desde griferías temporizadas para optimizar el consumo, hasta duchitas especiales para WC o modelos gerontológicos. Una propuesta completa pensada para garantizar confort, higiene y máximo rendimiento en cada instalación.

Our Public Sector range brings together four collections designed to meet the demands of high-use environments. Solutions that combine efficiency, safety and durability in public and collective spaces. From timed taps that optimise water consumption to special WC hand showers or gerontological models. A comprehensive proposal conceived to guarantee comfort, hygiene and maximum performance in every installation.

Notre gamme pour Collectivités réunit quatre collections conçues pour répondre aux exigences des espaces à usage intensif. Des solutions qui associent efficacité, sécurité et durabilité dans les environnements publics et collectifs. Des robinetteries temporisées pour optimiser la consommation aux douchettes spéciales pour WC ou aux modèles gérontologiques. Une offre complète pensée pour garantir confort, hygiène et performance maximale dans chaque installation.

Índice colectividades.

Index.
Indice.



Temporizadas 182



Sensor 184



Especiales 186



Impala 190

COLECTIVIDADES

Colección TEMPORIZADAS



La colección Temporizadas incorpora atractivos diseños de grifos con pulsador, con vasos de diferente caudal, de 4 a 14 litros, y con tiempos de cierre de 3,4,7 y hasta 10 segundos.

The "Temporizados" collection features attractive push-button tap designs, with flow rates ranging from 4 to 14 litres, and closing times of 3, 4, 7, and up to 10 seconds.

La collection "Temporizados" propose d'élégants modèles de robinets à poussoir, avec des débits allant de 4 à 14 litres et des temps de fermeture de 3, 4, 7 et jusqu'à 10 secondes.



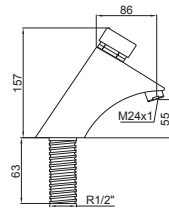

Grifo temporizado de lavabo con pulsador de cierre automático de 10 segundos. Caudal de 5 l/m.

Bathroom push button tap, 10 sec. self-closing. Flow rate 5 l/m.

Robinet poussoir pour lavabo en laiton, fermeture automatique en 10 secs. Débit 5 l/m.



Adaptable a nivel BSC 5

REFERENCIA PVP



89112

89,20 €

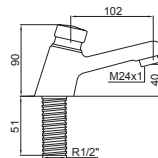

Grifo temporizado para lavabo con pulsador de cierre automático de 7 segundos.

Brass bathroom push button tap, 7 sec. self-closing.

Robinet poussoir pour lavabo en laiton, fermeture automatique en 7 secs.



REFERENCIA PVP



89113

72,32 €

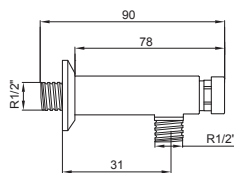

Grifo temporizado para ducha de 1/2" con pulsador de cierre automático.

Shower push button tap 1/2", self-closing.

Robinet poussoir pour douche 1/2", fermeture automatique.



REFERENCIA PVP



89800

62,44 €

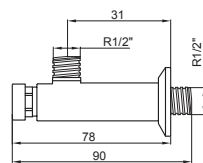

Grifo temporizado urinario de 1/2" con pulsador de cierre automático 3 segundos.

Urinary push button tap 1/2", 3 sec. self-closing.

Robinet poussoir pour urinaire 1/2", fermeture automatique 3 secs.



REFERENCIA PVP



89801

77,75 €

Colección SENSOR



Grifo Sensor, dotado de sensor infrarrojo de alta precisión. Diseño minimalista vanguardista. Acabados cromo.

Sensor tap equipped with a high-precision infrared sensor. Cutting-edge minimalist design. Chrome finish.

Robinet Sensor, doté d'un capteur infrarouge haute précision. Design minimaliste d'avant-garde. Finition chrome.



Sensor infrarrojo ultrarápido.



Ahorro 50%.

COLECTIVIDADES
Sensor

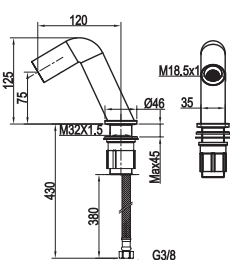

Grifo electrónico con sensor infrarrojo para lavabo, agua fría o premezclada. Alimentación eléctrica dual, pilas o conexión eléctrica alterna.

Electronic basin mixer with infrared sensor, cold or mixed water. Dual power supply, batteries or AC power connection.

Mitigeur lavabo infrarouge électronique, eau froide ou prémélangée. Double alimentation, piles ou branchement secteur.



REFERENCIA PVP

51101 | 264,84 €



Llave de ajuste de mezcla de temperatura para Sensor.

Temperature basin mixture adjustment key.

Clé de réglage de température.

REFERENCIA PVP

4112 | 13,54 €

Colección ESPECIALES



Descubre nuestra colección de duchitas para WC, una solución práctica y elegante que sustituye al bidé y la escobilla tradicional. Su fácil instalación permite incorporarlas en cualquier espacio, mejorando la higiene y el confort diario. Disponibles en una amplia gama de diseños y acabados.

Discover our collection of WC hand showers, a practical and elegant solution that replaces the bidet and traditional toilet brush. Their easy installation makes them suitable for any space, enhancing hygiene and daily comfort. Available in a wide range of designs and finishes.

Découvrez notre collection de douchettes pour WC, une solution pratique et élégante qui remplace le bidet et la brosse traditionnelle. Leur installation facile permet de les intégrer dans tout espace, améliorant l'hygiène et le confort au quotidien. Disponibles en une large gamme de designs et finitions.





Grifo monomando de empotrar para bidé con duchita. Flexo INOX 304 de 1 m. Caudal de 12 l/m.
 Concealed single-lever bidet mixer with hand shower. 1 m 304 stainless steel hose. Flow rate: 12 l/min.
 Mitigeur bidet encastré avec douchette. Flexible inox 304 de 1 m. Débit : 12 l/min.

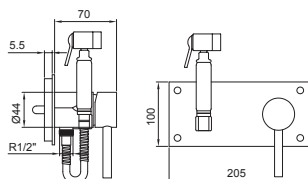
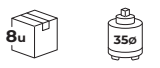

REFERENCIA PVP

82111 | 473,43 €



Grifo monomando para bidé con duchita frontal. Flexo INOX 304 de 1,20 m. Caudal de 12 l/m.
 Single-lever bidet mixer with front hand shower. 1.20 m 304 stainless steel hose. Flow rate: 12 l/min.
 Mitigeur bidet avec douchette frontale. Flexible inox 304 de 1,20 m. Débit : 12 l/min.

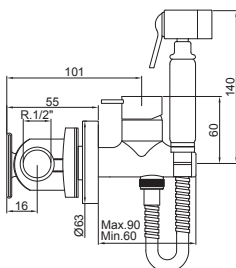

REFERENCIA PVP

82112 | 249,15 €



Grifo monomando mural para bidé con flexo INOX 304 de 1,25 m y duchita lateral tubular. Caudal de 10,5 l/m.
 Wall-mounted single-lever bidet mixer with 1.25 m 304 stainless steel hose and tubular side hand shower. Flow rate: 10.5 l/min.
 Mitigeur mural pour bidet avec flexible inox 304 de 1,25 m et douchette latérale tubulaire. Débit : 10,5 l/min.

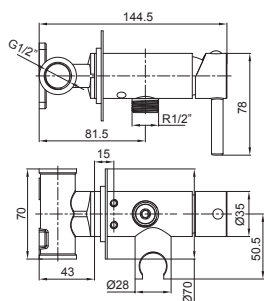
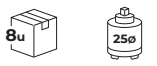

REFERENCIA PVP

- 82113 | 84,43 €
- 82113/N | 92,32 €
- 82113/NQ | 99,75 €
- 82113/G | 99,75 €
- 82113/BC | 105,40 €
- 82113/RG | 99,75 €

ESPECIALES





Grifo mezclador cuadrado para bidé con flexo INOX 304 de 1,25 m y ducha lateral cuadrada con caudal de 10,5 l/m.

Square mixer tap for bidet with 1.25 m INOX 304 hose and square side hand shower. Flow rate: 10.5 l/min.

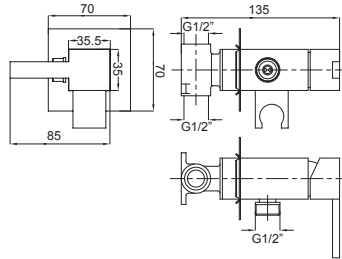
Mitigeur carré pour bidet avec flexible INOX 304 de 1,25 m et douchette latérale carrée. Débit : 10,5 l/min.



REFERENCIA PVP

	82114	93,04 €
	82114/N	99,88 €







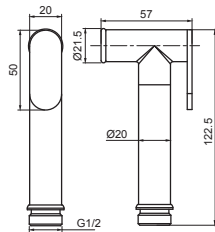

Duchita para WC tubular.

Tubular WC hand shower.

Douchette WC tubulaire.



REFERENCIA PVP

	5010	61,82 €
	5010/N	55,75 €
	5010/NQ	57,47 €
	5010/G	57,47 €
	5010/BC	57,47 €
	5010/RG	57,47 €



Duchita para wc, con flexo extensible de 1m a 1,5 m. Tuercas de latón de 1/2".

Toilet hand shower.

Douchette pour WC.

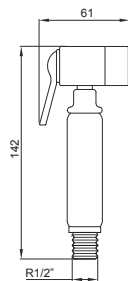

REFERENCIA PVP

	4035	61,82 €
---	------	---------



Flexo latón extensible 1 m a 1,5 m para duchita WC.
 Brass extendable hose 1 m to 1.5 m for WC hand shower.
 Flexible en laiton extensible de 1 m à 1,5 m pour douchette WC.

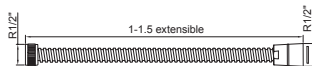

REFERENCIA	PVP
 4035/F	11,86 €
 4035/F/N	14,58 €
 4035/F/NQ	19,85 €
 4035/F/G	19,85 €
 4035/F/BC	21,74 €
 4035/F/RG	21,74 €



COLECTIVIDADES
Especiales

Colección IMPALA



Colección de grifos con maneta gerontológica, ideales para ubicaciones con elevados requerimientos higiénicos. Incorporan palanca de largo alcance accesible con codo o brazo. Diseño amigable y moderno con acabados en cromo.

Collection of taps with gerontological handle, ideal for locations with high hygiene requirements. Feature a long-reach lever that can be operated with the elbow or forearm. User-friendly and modern design with chrome finish.

Collection de robinets avec poignée g erontologique, id eaux pour les espaces aux exigences d'hygi ene  lev ees. Dot es d'un levier   longue port ee, accessible avec le coude ou l'avant-bras. Design convivial et moderne avec finition chrome.



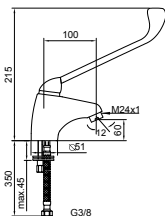

Grifo mezclador para lavabo con palanca gerontológica.
 Gerontological basin mixer with long lever elbow and swivel spout.
 Robinet gérontologique mitigeur lavabo, avec levier long, coude et bec pivotant.

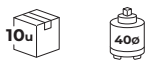

REFERENCIA PVP



15107

123,25 €

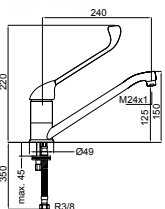
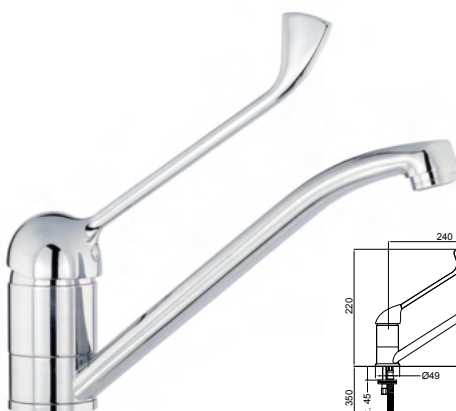

Grifo mezclador para fregadero mural con caño bajo, con palanca gerontológica. Caudal de 10 l/m.
 Gerontological wall-mounted kitchen mixer with long lever elbow and swivel spout.
 Robinet gérontologique mural pour cuisine, avec levier long coude et bec pivotant.



REFERENCIA PVP



15651/76

215,66 €



Grifo mezclador para lavabo o fregadero con caño giratorio inclinado y palanca gerontológica.
 Gerontological wall-mounted kitchen or basin mixer with long lever elbow and swivel spout.
 Robinet gérontologique pour cuisine ou lavabo, avec levier long coude et bec pivotant.



REFERENCIA PVP



15660

149,23 €

Producto
Relacionado



Ref. 91056F

Sifón de latón cilíndrico.
 Brass siphon.
 Siphon laiton.

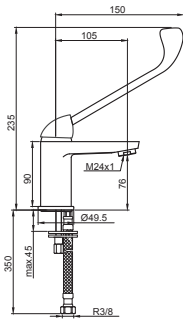

Monomando lavabo con maneta gerontológica. Caudal de 5 l/m.

Mitigeur de lavabo, avec manette gérontologique. Débit de 5 l/min.

Single-lever basin mixer, with elbow-action handle. Flow rate of 5 l/min.



Adaptable a nivel BSC 5

REFERENCIA PVP

14107/GER | 60,30 €

14107/N/GER | 73,48 €

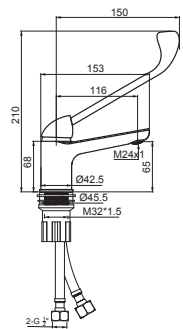

Monomando lavabo con maneta gerontológica y apertura en frío. Caudal de 5 l/m.

Mitigeur de lavabo, avec manette gérontologique et ouverture sur l'eau froide C3. Débit de 5 l/min.

Single-lever basin mixer, with elbow-action handle and gentle cold start. Flow rate of 5 l/min.



Adaptable a nivel BSC 5

REFERENCIA PVP

56107/GER | 63,45 €

56107/N/GER | 75,80 €

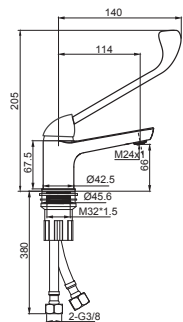

Monomando lavabo con maneta gerontológica y apertura en frío. Caudal de 5 l/m.

Mitigeur de lavabo, avec manette gérontologique et ouverture sur l'eau froide C3. Débit de 5 l/min.

Single-lever basin mixer, with elbow-action handle and gentle cold start. Flow rate of 5 l/min.



Adaptable a nivel BSC 5

REFERENCIA PVP

57107/GER | 63,45 €

57107/N/GER | 75,80 €

Producto Relacionado



Ref. 4025

Desagüe pulsador rápido de latón clic-clac con rosca de 1" 1/4.

Brass clic-clac pop-up waste with 1" 1/4 thread.

Bonde laiton clic-clac, 1" 1/4.

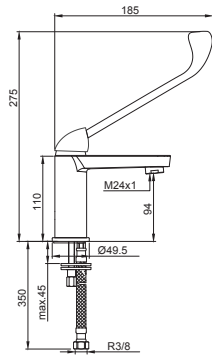

Monomando lavabo con maneta gerontológica. Caudal de 5 l/m.
 Mitigeur de lavabo, avec manette gérontologique. Débit de 5 l/min.
 Single-lever basin mixer, with elbow-action handle. Flow rate of 5 l/min.

12u 350 ACS Saving Water

BOET BSC 4
 Adaptable a nivel BSC 5

REFERENCIA	PVP
14109/GER	72,25 €
14109/N/GER	80,29 €

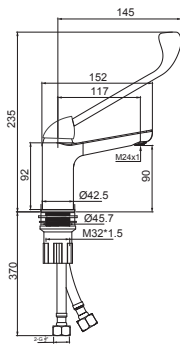

Monomando lavabo con maneta gerontológica y apertura en frío. Caudal de 5 l/m.
 Mitigeur de lavabo, avec manette gérontologique et ouverture sur l'eau froide C3. Débit de 5 l/min.
 Single-lever basin mixer, with elbow-action handle and gentle cold start. Flow rate of 5 l/min.

10u 350 Saving Water

BOET BSC 4
 Adaptable a nivel BSC 5

REFERENCIA	PVP
56109/GER	73,25 €
56109/N/GER	83,80 €

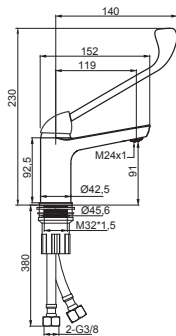

Monomando lavabo con maneta gerontológica y apertura en frío. Caudal de 5 l/m.
 Mitigeur de lavabo, avec manette gérontologique et ouverture sur l'eau froide C3. Débit de 5 l/min.
 Single-lever basin mixer, with elbow-action handle and gentle cold start. Flow rate of 5 l/min.

10u 350 Saving Water

BOET BSC 4
 Adaptable a nivel BSC 5

REFERENCIA	PVP
57109/GER	73,25 €
57109/N/GER	83,80 €

COLECTIVIDADES Impala

Producto Relacionado



Ref. 91056F

Sifón de latón cilíndrico.
 Brass siphon.
 Siphon laiton.

Complementos BOET



Diseño, calidad y adaptabilidad se combinan en nuestra colección de complementos, creados para armonizar con cada una de nuestras colecciones. Piezas pensadas para completar el baño con funcionalidad, coherencia estética y el sello distintivo de Boet.

Design, quality, and adaptability come together in our collection of accessories, created to harmonize with each of our faucet collections. Pieces designed to complete the bathroom with functionality, aesthetic coherence, and the distinctive Boet signature.

Design, qualité et adaptabilité se conjuguent dans notre collection d'accessoires, créés pour s'harmoniser avec chacune de nos collections. Des pièces pensées pour compléter la salle de bains avec fonctionnalité, cohérence esthétique et la signature distinctive de Boet.



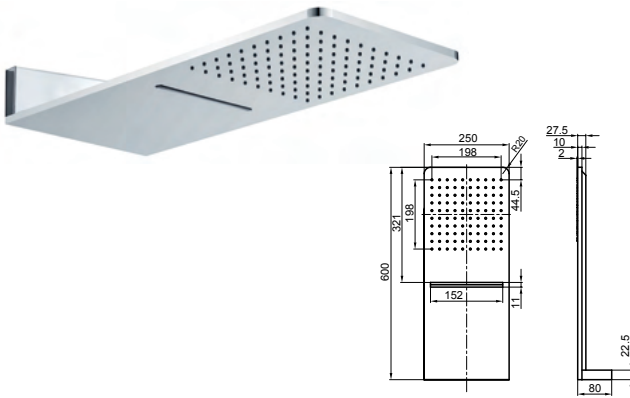

Rociador con cascada slim cuadrado de dos vías INOX 304 y caudal 11 l/m.

Slim square overhead shower with dual outlet and waterfall function, made of INOX 304. Flow rate: 11 l/min.

Pomme de douche pluie et cascade en acier INOX 304 carrée. Débit 11 l/m.



REFERENCIA	PVP
4061	630,71 €
4061/N	662,21 €
4061/NQ	784,91 €
4061/G	784,91 €
4061/BC	784,91 €

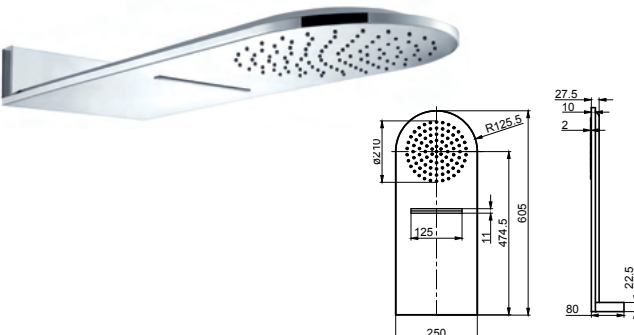

Rociador con cascada slim de dos vías redondeado INOX 304 y caudal 11 l/m.

Slim rounded overhead shower with dual outlet and waterfall function, made of INOX 304. Flow rate: 11 l/min.

Pomme de douche pluie et cascade en acier INOX 304 ronde. Débit 11 l/m.



REFERENCIA	PVP
4062	604,42 €
4062/N	637,68 €

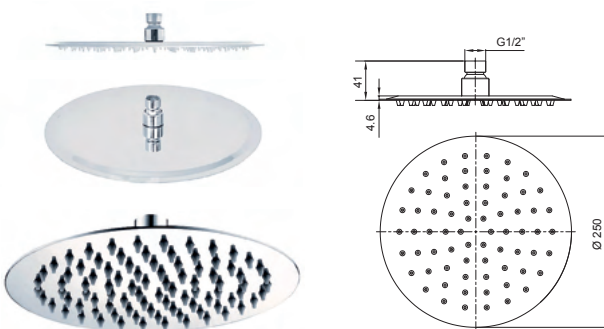

Rociador ducha INOX slim Ø 250 mm con sistema anticalcáreo.

Stainless steel slim shower head Ø 250 mm with anti-limescale system.

Pomme de douche fine en acier inoxydable Ø 250 mm avec système anticalcaire.



REFERENCIA	PVP
4084/25	44,66 €
4084/25/N	57,40 €
4084/25/NQ	63,09 €
4084/25/G	63,09 €
4084/25/BC	66,40 €
4084/25/RG	65,20 €



COMPLEMENTOS

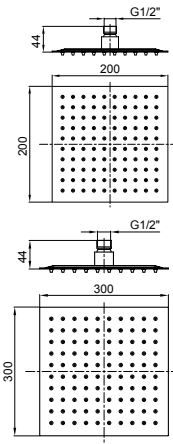

Rociador autoclean INOX slim 3 mm, cuadrado.

Inox squared fixed shower head anti calcareous 3 mm.

Tête de douche carrée inox anti calcaire 3 mm.



REFERENCIA	PVP
200x200 mm.	

● 4087 | 39,27 €

● 4087/N | 43,19 €

REFERENCIA	PVP
300x300 mm.	

● 4095 | 92,98 €

● 4095/N | 97,62 €

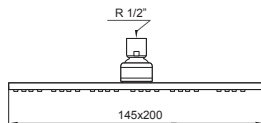

Rociador de latón rectangular 200 x 145 mm autoclean.

Squared fixed shower head anti calcareous 200 x 145 mm.

Tête de douche laiton carrée anti calcaire 200 x 145 mm.



REFERENCIA	PVP
● 4019	206,68 €

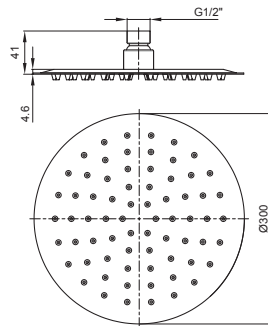

Rociador INOX autoclean slim 3 mm, ø300 mm.

Inox rounded fixed shower head anti calcareous 3 mm, ø300 mm.

Tête de douche inox ronde anti calcaire 3 mm, ø300 mm.



REFERENCIA	PVP
● 4089	92,98 €
● 4089/N	97,62 €

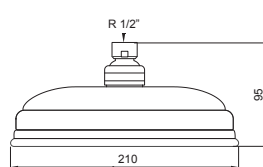

Rociador de latón redondo ø210 mm.

Brass rounded fixed shower head anti calcareous 210 mm diameter.

Tête de douche laiton ronde anti calcaire ø210 mm.



REFERENCIA	PVP
● 4016	122,85 €



Brazo de ducha fijo de latón, tubular a pared, 34 cm de largo.

Brass fixed shower arm 34 cm.

Bras de douche fix laiton, longueur 34 cm.

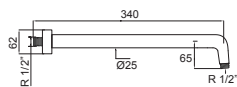

REFERENCIA PVP

	4013	35,95 €
	4013/N	39,74 €
	4013/NQ	51,93 €
	4013/G	51,93 €
	4013/BC	53,81 €
	4013/RG	52,90 €



Brazo de ducha fijo de latón, cuadrado a pared, 38,5 cm de largo.

Fixed square wall-mounted brass shower arm, 38.5 cm long.

Bras de douche fixe laiton carré, longueur 38,5 cm.

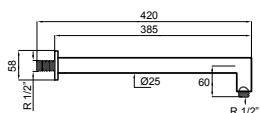

REFERENCIA PVP

	4014	68,77 €
	4014/N	75,64 €



Brazo de ducha fijo cónico de latón, 145 mm de largo. Rosca de 1/2".

Brass fixed shower arm, 145 mm length.

Bras de douche fixe laiton, longueur 145 mm.

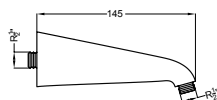

REFERENCIA PVP

	4010	33,98 €
--	------	---------



Brazo fijo de ducha de latón para techo, 20 cm de largo.

Brass fixed top shower arm 20 cm.

Bras de douche fixe laiton, longueur 20 cm.

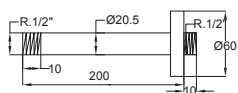

REFERENCIA PVP

	4096	43,32 €
	4096/N	43,84 €
	4096/NQ	43,91 €
	4096/G	43,91 €
	4096/BC	44,85 €
	4096/RG	44,20 €

NOVEDAD



Caño para bañera redondo.

Round spout for bathtub.

Bec rond pour baignoire.

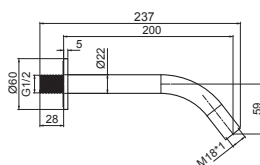

REFERENCIA PVP

	SP-010	23,95 €
	SP-010/N	29,59 €
	SP-010/NQ	41,65 €
	SP-010/G	41,67 €
	SP-010/BC	45,68 €
	SP-010/RG	45,68 €

COMPLEMENTOS

COMPLEMENTOS



Mango de ducha ABS 5 posiciones sistema autoclean.
 ABS hand shower 5 positions auto clean.
 Douchette ABS à 5 positions, anti calcaire.

REFERENCIA	PVP
4083	22,51 €

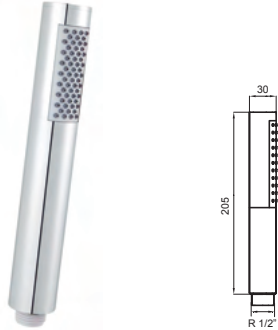

Mango de ducha ABS, sistema autoclean.
 ABS hand shower anti calcareous.
 Douchette ABS anti calcaire.

REFERENCIA	PVP
4067	25,59 €

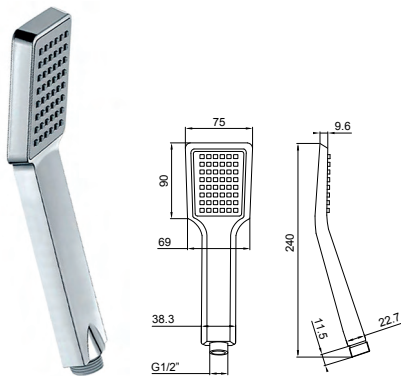

Mango de ducha cuadrado ABS autoclean.
 Squared anti calcareous hand shower.
 Douchette ABS carrée anticalcaire.

REFERENCIA	PVP
4057	19,66 €



Mango de ducha ABS con pulsador de 4 posiciones y sistema autoclean.
 ABS showerhead with 4-position push button and anti-limescale system.
 Douchette ABS avec bouton à 4 positions, anticalcaire.

REFERENCIA	PVP
4086	15,43 €
4086/N	28,26 €
4086/NQ	28,69 €
4086/G	28,69 €
4086/BC	30,12 €
4086/RG	29,50 €



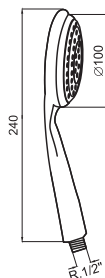

Mango de ducha ABS con sistema autoclean.
 ABS hand shower anti calcaireous.
 Douchette ABS anti calcaire.

REFERENCIA	PVP
------------	-----

4097	14,67 €
------	---------

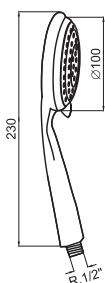

Mango de ducha ABS con 3 posiciones autoclean.
 ABS hand shower 3 positions auto clean.
 Douchette ABS á 3 positions, anti calcaire.

REFERENCIA	PVP
------------	-----

4076	16,85 €
------	---------

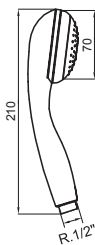

Mango de ducha ABS con sistema autoclean.
 ABS hand shower anti calcaireous.
 Douchette ABS anti calcaire.

REFERENCIA	PVP
------------	-----

4064	14,31 €
------	---------

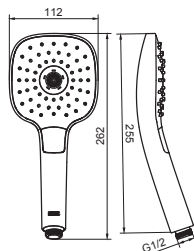

Mango de ducha ABS con 3 posiciones autoclean.
 ABS hand shower 3 positions auto clean.
 Douchette ABS á 3 positions, anti calcaire.

REFERENCIA	PVP
------------	-----

4117	28,33 €
------	---------



COMPLEMENTOS

COMPLEMENTOS

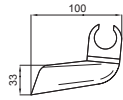

Soporte para mango de ducha ABS orientable 2 posiciones.

*Adjustable 2 positions shower head bracket ABS.
Support pour douchette ABS réglable 2 positions.*



REFERENCIA	PVP
------------	-----

 4020	11,32 €
 4020/N	12,53 €

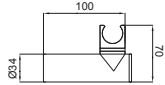

Soporte de ducha ABS orientable cilíndrico.

*Adjustable shower head bracket ABS.
Support pour douchette réglable.*



REFERENCIA	PVP
------------	-----

 4026	21,29 €
--	---------

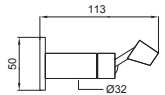
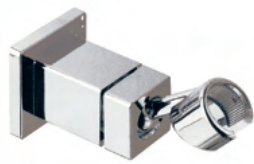

Soporte de ducha ABS cuadrado con rótula orientable.

*Ball joint adjustable ABS shower head bracket.
Support pour douchette avec rotule réglable.*



REFERENCIA	PVP
------------	-----

 4041	19,91 €
--	---------

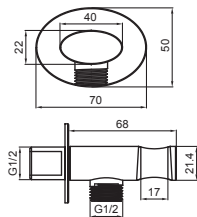

Soporte de latón para mango de ducha con toma de agua, roscas 1/2", caudal 20 l/m.

Shower outlet elbow with holder, 1/2" threads. Flow rate: 20 l/min.

Support de douche mural en laiton avec prise d'eau intégrée. Écrous 1/2". Débit 20 l/m.

REFERENCIA	PVP
------------	-----

 4047	41,81 €
--	---------

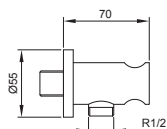





Soporte de latón para mango de ducha con toma de agua, roscas 1/2", caudal 20 l/m.

Shower outlet elbow with holder, 1/2" threads. Flow rate: 20 l/min.

Support de douche mural en laiton avec prise d'eau intégrée. Écrous 1/2". Débit 20 l/m.



REFERENCIA	PVP
------------	-----

 4047/N	43,95 €
 4047/NQ	49,75 €
 4047/G	49,75 €
 4047/BC	50,52 €
 4047/RG	50,25 €



Flexo de ducha en acero INOX (AISI 304) 1,70 m, tuercas latón 1/2".
 1.70 m stainless steel (AISI 304) shower hose with brass 1/2" nuts.
 Flexible INOX (AISI 304) 1,70m. Écrous laiton 1/2".

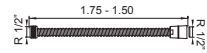

REFERENCIA	PVP
4033	11,03 €
4033/N	18,63 €
4033/NQ	30,87 €
4033/G	30,87 €
4033/BC	34,66 €
4033/RG	32,84 €



Flexo de ducha con manguera de PVC sin torsión, 1,5 m. Tuercas de latón 1/2".
 PVC anti-twist shower hose, 1.50 m, 1/2" brass nuts.
 Flexible de douche en PVC anti-torsion, 1,50 m, écrous en laiton 1/2".

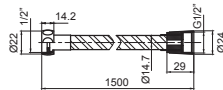

REFERENCIA	PVP
4033/SV	14,78 €



Desagüe de varilla cilíndrico.
 Cylindrical click-clack basin waste.
 Vidage clic-clac cylindrique.

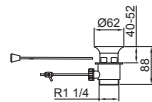

REFERENCIA	PVP
4024	29,21 €



Desagüe pulsador rápido de latón clic-clac con rosca de 1" 1/4.
 Brass clic-clac pop-up waste with 1" 1/4 thread.
 Bonde laiton clic-clac, 1" 1/4.

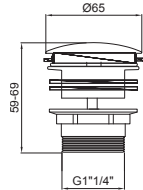

REFERENCIA	PVP
4025	18,37 €
4025/N	20,21 €
4025/NQ	22,78 €
4025/G	22,78 €
4025/BC	22,78 €
4025/RG	22,78 €



Sifón cilíndrico visto extensible.
 Cylindrical and mounted siphon with extended rod.
 Siphon cylindrique visible, extensible.

REFERENCIA	PVP
4023	157,23 €

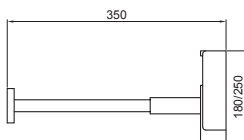

Sifón de latón cilíndrico.
 Brass siphon.
 Siphon laiton.

REFERENCIA	PVP
91056F	57,80 €
91056F/N	59,39 €
91056F/NQ	64,75 €
91056F/G	64,75 €
91056F/BC	67,90 €
91056F/RG	66,85 €

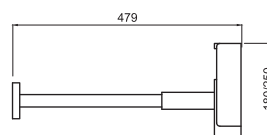

COMPLEMENTOS



Kit de ducha con mango de ducha ABS autoclean de 5 posiciones, flexo de latón extensible, tuercas de 1/2" y soporte ABS orientable.

3 positions hand shower, extensible flexible and adjustable head bracket shower kit.

Kit de douche avec douchette 3 positions, flexible extensible et support pour douchette réglable.



REFERENCIA PVP



4048N

27,89 €

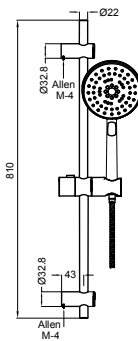
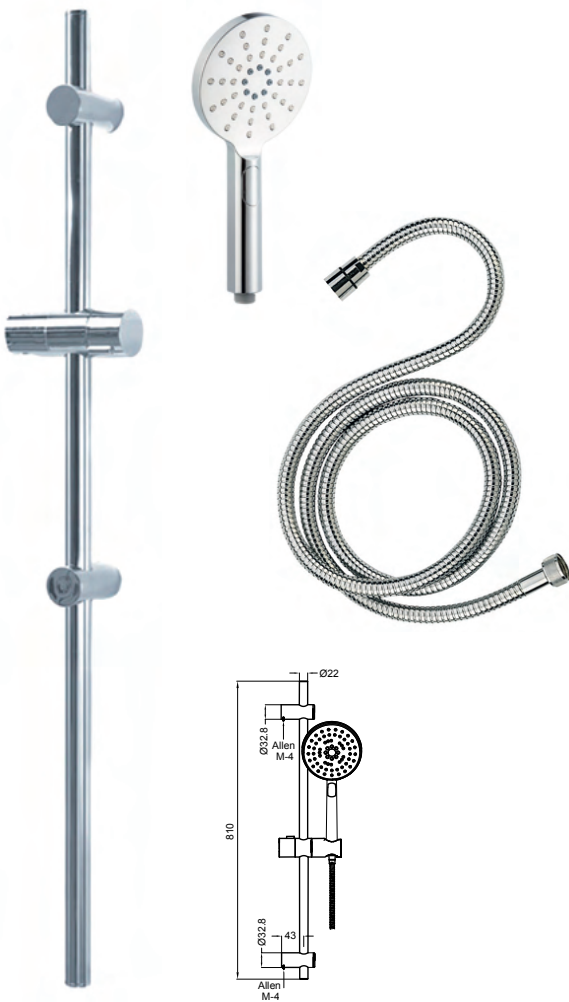
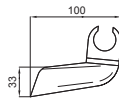
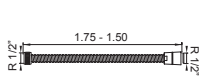

Barra de ducha deslizante de latón con flexo y mango de ducha ABS autoclean.

Sliding bar with flexible and hand shower.

Barre de douche avec curseur ajustable avec flexible et douchette.

REFERENCIA PVP



4102

60,81 €

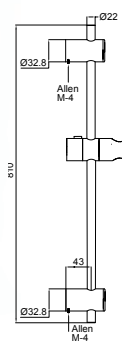

Barra de ducha tubular de latón con soporte deslizante.

Shower riser rail kit with height adjustable shower holder.

Kit barre de douche avec hauteur de douchette réglable.

REFERENCIA PVP



4100

48,91 €





Pack de accesorios de ducha para empotrados de 2 vías: Brazo pared cuadrado, rociador cuadrado 20 cm, soporte con toma, flexo y mango de ducha cuadrado ABS autoclean.

Accessories shower pack for 2 ways wall mounted single-lever: wall arm, 20 cm round shower head, support with water connection, hose and shower handle.

Pack d'accessoires pour douche pour robinets muraux à 2 voies : bras mural, pomme de douche carrée de 20 cm, support avec raccord d'eau, flexible et douchette carrée anti calcaire.

REFERENCIA PVP

Shower Set1 | 188,95 €



Pack accesorios ducha para empotrados de 2 vías: Brazo pared tubular, rociador redondo ø 20 cm, soporte con toma, flexo y mango de ducha ABS autoclean.

Accessories shower pack for 2 ways wall mounted single-lever: wall arm, 20 cm round shower head, support with water connection, hose and shower handle.

Pack d'accessoires pour douche avec robinets muraux à 2 voies : bras mural, pomme de douche ronde de 20 cm, support avec raccord d'eau, flexible et douchette anti calcaire.

REFERENCIA PVP

Shower Set2 | 158,06 €

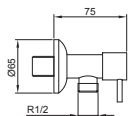

Tubular llave de corte de 1/2" x1/8".

Wall mounted stop tap 1/2" x1/8".

Robinet d'arrêt encastrable 1/2" x1/8".

REFERENCIA PVP

4022 | 8,30 €

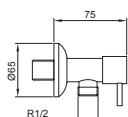

Tubular llave de corte de 1/2" x1/2".

Wall mounted stop tap 1/2" x1/2".

Robinet d'arrêt encastrable 1/2" x1/2".

REFERENCIA PVP

4022/1 | 8,30 €



BOET

RECAMBIOS

Spare Parts

Pièces de rechange

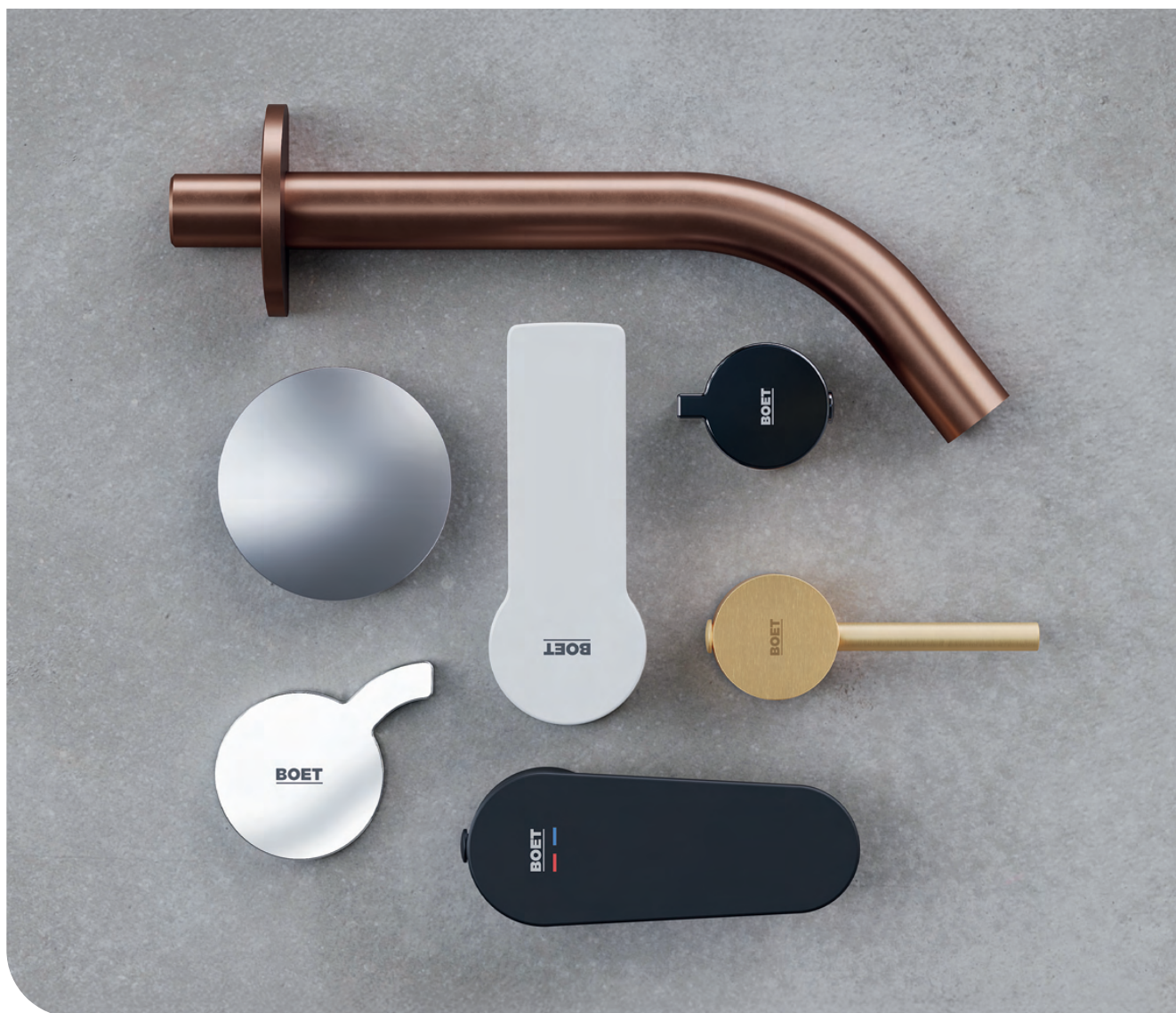











Este capítulo reúne los recambios específicos de cada colección, disponibles para sustituir cualquier pieza de nuestras griferías con total garantía. Un servicio de valor añadido que acompaña al producto durante toda su vida útil.

This chapter brings together the specific spare parts for each collection, available to replace any component of our fittings with full assurance. A value-added service that supports the product throughout its entire lifetime.

Ce chapitre regroupe les pièces de rechange spécifiques à chaque collection, disponibles pour remplacer n'importe quel élément de nos robinetteries en toute garantie. Un service à valeur ajoutée qui accompagne le produit tout au long de sa vie utile.

ANTIQUE

Denominación	Asignado a	Referencia	Uds. Blister	PVP
 Volante Antique con tornillo inox. <i>Antique handle with stainless steel screw.</i> <i>Poignée Antique avec vis en inox.</i>	72147 72247 72556 72426 72656	A-508	 1 unidad	30,53 €
 Montura cerámica ½ vuelta. <i>½ turn ceramic headwork.</i> <i>Tête céramique ½ tour.</i>	72147 72247 72556 72426 72656	A-20	 1 unidad	29,34 €
 Aireador M-22x100 (H). <i>Aerator M-22x100 (F).</i> <i>Aérateur M-22x100 (F).</i>	72147 72247 72656	A-308	 2 unidades	7,65 €
 Rotula bidé M-22 x M-22 (M-H). <i>Basin bidet swivel joint M-22 x M-22 (M-F).</i> <i>Raccord orientable pour bidet M-22 x M-22 (M-F).</i>	72247	A-306	 1 unidad	8,10 €
 Caño de tubo. <i>Tube spout.</i> <i>Bec en tube.</i>	72656	A-964	 1 unidad	31,21 €









APOLO

Denominación	Asignado a	Referencia	Uds. Blister	PVP
 Volante Apolo. <i>Apolo Handle.</i> <i>Poignée Apolo.</i>	22107 22227 22424 22555	AM-369	 1 unidad	16,60 €
 Cartucho Ø25 progresivo. <i>Ø25 Progressive Cartridge.</i> <i>Cartouche Ø25 Progressive.</i>	22107 22227 22424 22555	AM-59	 1 unidad	15,98 €
 Aireador M-22x100 (H) <i>Aerator Thread M22x100 (F).</i> <i>Aérateur Filetage M22x100 (F).</i>	22227	A-308	 2 unidades	7,65 €
 Aireador M-24x100 giroscópico <i>Swivel Aerator M24x100.</i> <i>Aérateur Orientable M24x100.</i>	22555 22107	A-344	 2 unidades	8,19 €
 Aro base latón. <i>Brass base ring.</i> <i>Anneau de base en laiton.</i>	22107 22227	A-622	 1 unidad	7,98 €
 Rótula bidé. <i>Bidet Ball Joint.</i> <i>Rotule Bidet.</i> M22x100 x M24x100 (M-M).	22227	A-306	 1 unidad	8,10 €

ARES

	Denominación	Asignado a	Acabado	Referencia	Uds. Blister	PVP
	Maneta ARES Lavabo. <i>ARES Basin Handle.</i> <i>Poignée ARES Lavabo.</i>	34107		AM-365		13,84 €
		34107/B		AM-365/B		15,37 €
		34107/N		AM-365/N		15,37 €
	Maneta ARES baño ducha bidé. <i>ARES Bath/Shower/Bidet Handle.</i> <i>Poignée ARES Bain/Douche/Bidet.</i>	34227 34555 34424		AM-365/1		13,84 €
		34227/B 34555/B 34424/B		AM-365/1/B		13,84 €
		34227/N 34555/N 34424/N		AM-365/2/N		15,37 €
	Cartucho Ø35 salida junta superior. <i>Ø35 Cartridge With Upper Seal Outlet</i> <i>Cartouche Ø35 Sortie Joint Supérieure.</i>	34107 34227 34424 34555		AM-53		15,98 €
	Cartucho Ø35 salida conducido. <i>Ø35 Controlled Outlet cartridge.</i> <i>Cartouche Ø35 Sortie Conduite.</i>	34425 34556		AM-29		15,98 €
	Aireador M-22x100 (H). <i>Aerator Thread M22x100 (F).</i> <i>Aérateur Filetage M22x100 (F).</i>	34227		A-308		7,65 €
	Aireador M-24x100 giroscópico. <i>Swivel Aerator M24x100.</i> <i>Aérateur Orientable M24x100.</i>	34107 34555		A-344		8,19 €
	Aro base latón. <i>Brass base ring.</i> <i>Anneau de base en laiton.</i>	34227 34107		A-617		4,07 €
		34227B 34107/B		A-617/B		8,81 €
	Aro base latón negro. <i>Black Brass base ring.</i> <i>Anneau de base en laiton noir.</i>	34227N 34107/N		A-618/N		8,81 €
	Distribuidor. <i>Diverter.</i> <i>Distributeur.</i>	34555		A-139		15,41 €
	Rótula bidé M-22x100 x M-24x100 (M-M). <i>Bidet Ball Joint</i> <i>M22x100 x M24x100 (M-M).</i> <i>Rotule Bidet</i> <i>M22x100 x M24x100 (M-M)</i>	34227		A-334		7,19 €



BACK

	Denominación	Asignado a	Referencia	Uds. Blister	PVP
	Maneta Back. Back Handle. Poignée Back.	21107 21227 21555 21424 21658	AM-358	1 unidad	11,21 €
	Cartucho Ø40 salida conducida. Ø40 Controlled Outlet cartridge. Cartouche Ø40 Sortie Conduite.	21107 21227 21555 21424	AM-35	1 unidad	15,98 €
	Cartucho Ø40 salida libre. Ø40 Free Outlet cartridge. Cartouche Ø40 Sortie libre.	21658	AM-25	1 unidad	15,98 €
	Aireador M-22x100. Aerator M-22x100. Aérateur M-22x100.	21227	A-308	2 unidades	7,65 €
	Aireador M-24x100 (M). Aerator Thread M24x100 (M). Aérateur Filetage M24x100 (M).	21107 21658	A-331	2 unidades	6,75 €
	Cobertor M-42x1,25. Cover Thread M42x1.25. Cache Filetage M42x1,25.	21107 21227 21555 21424 21658	A-10	1 unidad	1,86 €
	Distribuidor. Diverter. Distributeur.	21555	A-112	1 unidad	12,31 €
	Rótula bidé M-24x100 x M-22x100 (M-M). Bidet Ball Joint M24x100 x M22x100 (M-M). Rotule Bidet M24x100 x M22x100 (M-M).	21227	A-306	1 unidad	8,10 €
	Caño Latón. Brass spout. Bec en laiton.	21657	A-940	1 unidad	53,88 €







CINCO

	Denominación	Asignado a	Referencia	Uds. Blister	PVP
	Maneta Cinco. Cinco Handle. Poignée Cinco.	65107 65227 65555 65424 65425 65660 65659/09 65652/06 65658/08 65556 65670	AM-342	1 unidad	6,46 €
		65651/58	AM-344		6,46 €
	Cartucho Ø 35 salida conducida. Ø35 Controlled Outlet cartridge. Cartouche Ø35 Sortie Conduite.	65556	AM-29	1 unidad	15,98 €
	Cartucho Ø 40 salida conducida. Ø40 Controlled Outlet cartridge. Cartouche Ø40 Sortie Conduite.	65107 65227 65555 65424 65425 65660 65670 65652/06 65658/08	AM-35	1 unidad	15,98 €
	Cartucho Ø 35 salida libre. Ø35 Free Outlet cartridge. Cartouche Ø35 Sortie libre.	65651/58	AM-28	1 unidad	15,98 €
	Cartucho Ø 40 salida libre. Ø40 Free Outlet cartridge. Cartouche Ø40 Sortie libre.	65659/09	AM-25	1 unidad	15,98 €
	Aireador M-24x100 (M). Aerator Thread M24x100 (M). Aérateur Filetage M24x100 (M).	65107 65555 65660 65652/06 65659/09 65658/08 65652/06	A-331	2 unidades	6,75 €
	Aireador M-22x100 (H). Aerator Thread M22x100 (F). Aérateur Filetage M22x100 (F).	65227 65651/58	A-308	2 unidades	7,65 €
	Rótula bidé. Bidet Ball Joint. Rotule Bidet. M24x100 x M22x100 (M-M).	65227	A-306	1 unidad	8,10 €
	Ducha extraíble. Pull-out Shower. Douche Extractible.	65670	A-303/40	1 unidad	33,00 €
	Flexo extraíble 1,50 cm. Pull-out Hose 1.50 m. Flexible Extractible 1,50 m.	65670	A-304/80	1 unidad	10,94 €
	Distribuidor. Diverter. Distributeur.	65555	A-117	1 unidad	26,65 €
	Caño Tubo. Spout Tube. Bec Tube.	65651/58	A-959	1 unidad	28,79 €
	Caño Fundido. Cast Spout. Bec Fonte.	65652/06	A-940	1 unidad	53,88 €
	Caño Tubo. Spout Tube. Bec Tube.	65658/08	A-946	1 unidad	31,19 €









CINCO

	Denominación	Asignado a	Referencia	Uds. Blister	PVP
	Caño Fundido. Cast Spout. Bec Fonte.	65659/09	A-952	1 unidad	47,72 €
	Tuerca latón M-42x1,5. Brass Nut Thread M42x1.5. Écrou Laiton Filetage M42x1,5.	65107 65227 65555 65424 65425 65660 65659/09 65670 65658/08 65652/06	A-104	1 unidad	8,92 €
	Cobertor M-37x1,5. Cover Thread M37x1.5. Cache Filetage M37x1,5.	65651/58 65556	A-11	1 unidad	2,52 €

CLASSIC





























	Denominación	Asignado a	Referencia	Uds. Blister	PVP
	Volante Classic. Classic handle. Poignée Classic.	75147 75247 75556 75426 75656	A-506	2 unidades	44,12 €
	Montura cerámica ¼ vuelta. ¼ turn ceramic headwork. Tête céramique ¼ tour.	75147/ 75247 75556 75426 75656	A-19	2 unidades	20,26 €
	Aireador M-22x100 (H). Aerator M-22x100 (F). Aérateur M-22x100 (F).	75247 75656	A-308	2 unidades	7,65 €
	Aireador M-24x100 (M). Aerator M-24x100 (M). Aérateur M-24x100 (M).	75147	A-331	2 unidades	6,75 €
	Rotula bidé M-24 x M-22 (M-M). Bidet swivel joint M-24 x M-22 (M-M). Raccord orientable pour bidet M-24 x M-22 (M-M).	75247	A-306	1 unidad	8,10 €
	Caño de tubo. Tube spout. Bec en tube.	75656	A-965	1 unidad	28,93 €

COCINAS

















	Denominación	Asignado a	Acabado	Referencia	Uds. Blister	PVP
	Maneta. Handle. Manette.	82690/07 82659 82681		AM-348/1	1 unidad	14,26 €
	Maneta cartucho osmosis. Osmosis cartridge handle. Manette cartouche osmose.	82700		AM-352	1 unidad	14,26 €
	Maneta BACK. BACK Handle. Poignée BACK.	21107 21227 21555 21424 21658		AM-358	1 unidad	11,21 €
	Maneta DUO. DUO Handle. Poignée DUO.	25107 25109 25227 25555 25424 25657		AM-361	1 unidad	8,76 €
	Maneta EROS. EROS Handle. Poignée EROS.	55657 55671		AM-372/ IAF	1 unidad	9,37 €
	Maneta ICE. ICE Handle. Poignée ICE.	26106 26107 26659 26681 26692		AM-361	1 unidad	8,76 €
	Maneta INOA. INOA Handle. Poignée INOA.	39657 39671		AM-362/ IAF	1 unidad	8,76 €
		39671/N		AM-362/ IAF/N		9,90 €
		39671/G		AM-362/ IAF/G		12,78 €
		39671/RG		AM-362/ IAF/RG		12,78 €
	Maneta montura. Valve handle. Manette tête.	82690/09 82690/07		AM-363	1 unidad	11,54 €
	Maneta NEOS. NEOS Handle. Poignée NEOS.	94107 94227 94555 94424 94556 94657 94658 94425		AM-354	1 unidad	13,14 €
	Maneta PLAY. PLAY Handle. Poignée PLAY.	98107 98227 98555 98424 98658		AM-356	1 unidad	11,79 €
	Cartucho Ø 35 junta superior apertura en frío. Ø35 Cartridge With Upper Seal, Cold-Start. Cartouche Ø35 Joint Supérieure, Ouverture à Froid.	55107 55109 55657 39107 39109 39657		AM-63	1 unidad	15,98 €
	Cartucho Ø 35 salida conducida 2 posiciones. Ø35 Two-Position Controlled Outlet cartridge. Cartouche Ø35 Sortie Conduite à Deux Positions.	25107 25109 25227 25555 25424 25657 14107 14109 14227 14555 14424 14657		AM-52	1 unidad	15,98 €

RECAMBIOS BOET







































COCINAS

	Denominación	Asignado a	Acabado	Referencia	Uds. Blister	PVP
	Cartucho Ø 35 salida conducida apertura en frío. Ø35 Controlled Outlet Cold-Start Cartridge. Cartouche Ø35 Sortie Conduite, Ouverture à Froid.	55671 39671		AM-65	 1 unidad	15,98 €
	Cartucho Ø 35 salida libre. Cartridge Ø 35 fixed cartridge Cartouche Ø 35 Sortie libre.	82700 94657		AM-28	 1 unidad	15,98 €
	Cartucho Ø40 salida libre. Ø40 Free Outlet cartridge. Cartouche Ø40 Sortie libre.	21658		AM-25	 1 unidad	15,98 €
	Aireador M-18 x 100 osmosis. Aerator M-18x100 osmosis. Aérateur M-18x100 osmose.	82700		A-324	 1 unidad	9,55 €
	Aireador. ABS Aerator Thread. Aérateur ABS Filetage. M-18.5x100 ABS 6l/m.	39657 55657		A-353	 2 unidades	8,37 €
	Aireador M-22x100 (H) Homologado IB. Aerator M-22x100 (F) Approved IB. Aérateur M-22x100 (F Homologué IB.	82690/09 82690/08 82710 25227 25657		A-308	 2 unidades	7,65 €
	Aireador M-22x100 5l/m. Aerator M22x100, 5 l/min. Aerator M22x100, 5 l/min.	14657		A-343	 2 unidades	7,65 €
	Aireador M-24x100 (M). Aerator Thread M24x100 (M). Aérateur Filetage M24x100 (M).	21107 21658 82700		A-331	 2 unidades	6,75 €
	Aireador M-24x100 (M) ABS. ABS Aerator Thread M24x100 (M). Aérateur ABS Filetage M24x100 (M).	94658		A-338	 2 unidades	6,62 €
	Aireador M-24x100 IB Homologado. Aerator M24x100 IB Approved. Aérateur M24x100 IB Homologué.	98107/98109 98658		A-341	 2 unidades	6,75 €
	Cobertor M-42x1,25. Cover Thread M42x1.25. Cache Filetage M42x1,25.	21107 21227 21555 21424 21658 82690/09 82690/08 82691 82680 82710 98107 98227 98555 98424 98658		A-10	 1 unidad	1,86 €
	Caño de tubo. Spout Tube. Bec Tube.	14657		A-970	 1 unidad	27,21 €
	Caño de tubo. Spout Tube. Bec Tube.	39657 55657		A-971	 1 unidad	27,21 €



















COCINAS

	Denominación	Asignado a	Acabado	Referencia	Uds. Blister	PVP
	Caño Latón. Brass spout. Bec en laiton.	21657		A-940		53,88 €
	Caño latón osmosis. Brass osmosis spout. Bec en laiton osmose.	82700		A-954		146,27 €
	Caño tubo abatible. Foldable tube spout. Bec tube rabattable.	82710		A-953		29,71 €
	Caño tubo rectangular. Rectangular Spout tube. Bec tube rectangulaire.	94657		A-963		42,77 €
	Cobertor M-37x1,5. Cover Thread M37x1.5. Cache Filetage M37x1,5.	14107 14109 14227 14555 14424 14657 25107 25109 25227 25555 25424 25657 55107 55109 55227 55424 55555 55657 55671 55425 55656 39107 39109 39227 39424 39555 39657 39671 39425 39656 82700 94107 94227 94555 94424 94657 94658		A-11		2,52 €
		14107/N 14109/N 14227/N 14555/N 14424/N 39107/N 39109/N 39227/N 39424/N 39555/N 39656/N 55107/N 55109/N 55227/N 55424/N 55555/N 55656/N		A-11/N		2,95 €
		39107/G 39109/G 39227/G 39424/G 39555/G 39656/G		A-11/G		3,50 €
		39107/RG 39109/RG 39227/RG 39424/RG 39555/RG 39656/RG		A-11/RG		3,50 €
	Montura cerámica ¼" vuelta. Ceramic headwork ¼ turn. Tête céramique ¼ tour.	82690/09 82690/08 82700		A-21		10,12 €
	Muelle. Spring. Ressort.	82690/09 82690/08 82691		4055		41,93 €































COLUMNAS

	Denominación	Asignado a	Acabado	Referencia	Uds. Blister	PVP
	Maneta Caudal zamak. <i>Flow handle zamak.</i> <i>Manette de débit zamak.</i>	50430		A-533C		11,29 €
		50430/N		A-533C/N		15,37 €
	Maneta. <i>Handle.</i> <i>Manette.</i>	47430		A-535/C		10,53 €
	Maneta JET. <i>JET handle.</i> <i>Manette JET.</i>	96430		AM-355		8,76 €
	Maneta Luca. <i>Luca handle.</i> <i>Manette Luca.</i>	14430		AM-362		8,76 €
	Maneta caudal. <i>Flow handle.</i> <i>Manette de débit.</i>	82430		A-532/C		10,53 €
		82430/N		A-532/C/N		12,00 €
		82430/G		A-532/C/G		15,25 €
		82430/BC		A-532/C/BC		15,25 €
		82430/NQ		A-532/C/NQ		15,25 €
		82430/RG		A-532/C/RG		15,25 €
	Maneta distribuidor zamak. <i>Diverter handle zamak.</i> <i>Manette distributeur zamak.</i>	50430		A-533/D		10,26 €
		50430/N		A-533/D/N		11,40 €
	Maneta distribuidor. <i>Diverter handle.</i> <i>Manette distributeur.</i>	82430		A-532/D		10,26 €
		82430/N		A-532/D/N		12,00 €
		82430/G		A-532/D/G		15,25 €
		82430/BC		A-532/D/BC		15,25 €
		82430/NQ		A-532/D/NQ		15,25 €
		82430/RG		A-532/D/RG		15,25 €
	Maneta distribuidor. <i>Diverter handle.</i> <i>Manette distributeur.</i>	47430		A-535/D		10,91 €
	Volante distribuidor. <i>Diverter handle.</i> <i>Manette distributeur.</i>	48430 48530		A-525/D		11,29 €
	Volante temperatura. <i>Temperature handle.</i> <i>Poignée de température.</i>	48430 48530		A-525/T		12,78 €
	Volante caudal. <i>Flow handle.</i> <i>Poignée de débit.</i>	35430		A-529/C		8,79 €

COLUMNAS

	Denominación	Asignado a	Acabado	Referencia	Uds. Blister	PVP
	Volante Temperatura. <i>Temperature handle.</i> <i>Poignée de température.</i>	35430		A-529/T	1 unidad	10,74 €
	Volante distribuidor. <i>Diverter handle.</i> <i>Manette distributeur.</i>	44430		A-530/CD	1 unidad	10,26 €
	Volante Temperatura. <i>Temperature handle.</i> <i>Poignée de température.</i>	44430		A-530/T	1 unidad	10,74 €
	Volante Termal. <i>Thermal handle.</i> <i>Poignée thermique.</i>	44431		A-531/T	1 unidad	9,17 €
		44431/N		A-531/T/N		11,60 €
		44431/G		A-531/T/G		12,20 €
		44431/BC		A-531/T/BC		12,20 €
		44431NQ		A-531/T/NQ		12,20 €
	Volante caudal. <i>Flow handle.</i> <i>Poignée de débit.</i>	44431		A-531/CD	1 unidad	8,79 €
		44431/N		A-531/CD/N		11,40 €
		44431/G		A-531/CD/G		12,20 €
		44431/BC		A-531/CD/BC		12,20 €
		44431NQ		A-531/CD/NQ		12,20 €
	Volante caudal ABS. <i>Flow handle ABS.</i> <i>Poignée de débit ABS.</i>	51430		A-534/C	1 unidad	8,79 €
		51430/N		A-534/C/N		11,40 €
	Volante Temperatura ABS. <i>Temperature handle ABS.</i> <i>Poignée de température ABS.</i>	51430		A-534T	1 unidad	9,17 €
		51430/N		A-534/T/N		11,40 €
	Cobertor M-42x1,25. <i>Cover Thread M42x1.25.</i> <i>Cache Filetage M42x1,25.</i>	Toda la familia Trianon		A-10	1 unidad	1,86 €
	Cartucho salida conducida. <i>Directed Outlet cartridge.</i> <i>Cartouche sortie dirigée.</i>	96430		AM-25	1 unidad	15,98 €
	Cartucho. <i>Cartridge.</i> <i>Cartouche.</i>	47430 82430		AM-27	1 unidad	15,98 €
	Cartucho termostático. <i>Thermostatic cartridge.</i> <i>Cartouche thermostatique.</i>	48430 48530 44430 44431 35430		AM-43	1 unidad	63,64 €
	Cartucho Ø35 junta superior. <i>Cartridge Ø35 upper seal outlet.</i> <i>Cartouche Ø35 sortie avec joint supérieur.</i>	14430		AM-53	1 unidad	15,98 €



























COLUMNAS

	Denominación	Asignado a	Acabado	Referencia	Uds. Blister	PVP
	Cartucho monomando. <i>Single-lever cartridge.</i> <i>Cartouche monocommande..</i>	50430		AM-69		15,98 €
	Cartucho distribuidor. <i>Diverter cartridge.</i> <i>Cartouche de distributeur.</i>	44430 44431		A-148		18,34 €
	Cartucho distribuidor. <i>Diverter cartridge.</i> <i>Cartouche de distributeur.</i>	48430 48530		A-149		18,34 €
	Distribuidor. <i>Diverter.</i> <i>Distributeur.</i>	82430		A-153		18,34 €
	Distribuidor. <i>Diverter.</i> <i>Distributeur.</i>	47430		A-155		18,34 €
	Distribuidor. <i>Diverter.</i> <i>Distributeur.</i>	50430 51430		A-159		18,34 €
	Montura cerámica 1/4". <i>Ceramic headwork.</i> <i>Tête céramique.</i>	35430		A-21		10,12 €
	Soporte deslizante. <i>Sliding holder.</i> <i>Support coulissant.</i>	44430 44431 35430 51430 50430 82430 96430		4073		8,70 €
		44431/N 51430/N 50430/N 82430/3/N		4073/N		10,05 €
		44431/G 82430/3/G		4073/G		12,20 €
		44431/BC 82430/3/BC		4073/BC		12,20 €
		44431/NQ 82430/3/NQ		4073/NQ		12,20 €
		82430/3/RG		4073/RG		12,20 €
	Soporte deslizante. <i>Sliding holder.</i> <i>Support coulissant.</i>	14430		4113		8,70 €
	Soporte deslizante barra. <i>Sliding bar holder.</i> <i>Support coulissant de barre.</i>	47430 48430 48530		4116		8,70 €
	Distribuidor. <i>Diverter.</i> <i>Distributeur.</i>	96430		A-142		35,07 €
	Distribuidor. <i>Diverter.</i> <i>Distributeur.</i>	14430		A-144		33,38 €

DUO

	Denominación	Asignado a	Referencia	Uds. Blister	PVP
	Maneta Duo. <i>Duo Handle.</i> <i>Poignée Duo.</i>	25107 25109 25227 25555 25424 25657	AM-361	1 unidad	8,76 €
	Cartucho Ø 35 salida conducida 2 posiciones. <i>Ø35 Two-Position Controlled Outlet cartridge.</i> <i>Cartouche Ø35 Sortie Conduite à Deux Positions.</i>	25107 25109 25227 25555 25424 25657	AM- 52	1 unidad	15,98 €
	Aireador M-22x100 (H) Homologado IB. <i>Aerator M22x100 (H) Approved IB.</i> <i>Aérateur M22x100 (H)</i> <i>Homologué IB.</i>	25227 25657	A-308	2 unidades	7,65 €
	Aireador M-24x100 (M) Homologado IB. <i>Aerator M24x100 (M) Approved IB.</i> <i>Aérateur M24x100 (M)</i> <i>Homologué IB.</i>	25107	A-310	2 unidades	7,65 €
	Aireador M-24x100 (M) Homologado (ID). <i>Aerator M24x100 (M) Approved (ID).</i> <i>Aérateur M24x100 (M)</i> <i>Homologué (ID)</i>	25555	A-352	2 unidades	7,65 €
	Cobertor M-37x1,25. <i>Cover Thread M37x1.25.</i> <i>Cache Filetage M37x1,25.</i>	25107 25109 25227 25555 25424 25657	A-11	1 unidad	2,52 €
	Distribuidor ABS. <i>ABS Diverter.</i> <i>Distributeur ABS.</i>	25555	A-112	1 unidad	12,31 €
	Rótula bidé M-24x100 x M-22x100 (M-M). <i>Bidet Ball Joint M24x100 x M22x100 (M-M).</i> <i>Rotule Bidet M24x100 x M22x100 (M-M).</i>	25227	A-306	1 unidad	8,10 €
	Caño de tubo. <i>Spout Tube.</i> <i>Bec Tube.</i>	25657	A-970	1 unidad	27,21 €









EROS

	Denominación	Asignado a	Acabado	Referencia	Uds. Blister	PVP
	Maneta EROS. Eros Handle. Poignée Eros.	55107		AM-372/AF	 1 unidad	9,37 €
		55107		AM-372/AF/N		10,40 €
		55227 55424 5555 5556/55		AM-372		9,37 €
		55227 55424 5555 5556/55		AM-372/N		10,40 €
		55657 55671		AM-372/IAF		9,37 €
	Cobertor M-37x1,25. Cover Thread M37x1.25. Cache Filetage M37x1,25.	55107 55109 55227 55424 55555 55657 55671 55425 55656		A-11	 1 unidad	2,52 €
		55107/N 55109/N 55227/N 55424/N 55555/N 55656/N		A-11/N		2,95 €
	Cartucho Ø 35 junta superior. Ø35 Cartridge With Upper Seal. Cartouche Ø35 Joint Supérieure.	55227 55424 55555		AM-53	 1 unidad	15,98 €
	Cartucho Ø 35 junta superior apertura en frío. Ø35 Cartridge With Upper Seal, Cold-Start. Cartouche Ø35 Joint Supérieure, Ouverture à Froid.	55107 55109 55657		AM-63	 1 unidad	15,98 €
	Cartucho Ø 35 salida conducida. Ø35 Controlled Outlet cartridge. Cartouche Ø35 Sortie Conduite.	55425 55556		AM-29	 1 unidad	15,98 €
	Cartucho Ø 35 salida conducida apertura en frío. Ø35 Controlled Outlet Cold-Start Cartridge. Cartouche Ø35 Sortie Conduite, Ouverture à Froid.	55671		AM-65	 1 unidad	15,98 €
	Aireador M-24x100 ABS. ABS Aerator Thread M24x100. Aérateur ABS Filetage M24x100.	55555		A-331	 2 unidades	6,75 €
	Aireador M-18.5x100 ABS 6l/m. ABS Aerator Thread M18.5x100, 6 l/min. Aérateur ABS Filetage M18.5x100, 6 l/min.	55657		A-353	 2 unidades	8,37 €
	Aireador M-24x100 ABS 5l/m. ABS Aerator Thread M24x100, 5 l/min. Aérateur ABS Filetage M24x100, 5 l/min.	55107 55109		A-354	 2 unidades	7,16 €
	Aireador M-22x100. Aerator Thread M22x100. Aérateur Filetage M22x100.	55227		A-308	 2 unidades	7,65 €





EROS

	Denominación	Asignado a	Acabado	Referencia	Uds. Blister	PVP
	Distribuidor ABS. <i>ABS Diverter.</i> <i>Distributeur ABS.</i>	55555		A-112		12,31 €
	Rótula bidé M-24x100 x M-22x100 (M-M). <i>Bidet Ball Joint</i> <i>M24x100 x M22x100 (M-M).</i> <i>Rotule Bidet</i> <i>M24x100 x M22x100 (M-M).</i>	55227		A-317		7,19 €
	Caño de tubo. <i>Spout Tube.</i> <i>Bec Tube.</i>	55657		A-971		27,21 €















ICE

	Denominación	Asignado a	Referencia	Uds. Blister	PVP
	Maneta ICE. <i>ICE Handle.</i> <i>Poignée ICE.</i>	26106 26107 26659 26681 26692	AM-364		8,50 €
	Cartucho Ø 35 salida junta superior. <i>Cartouche Ø35 Sortie Joint Supérieure.</i>	26106 26107	AM-53		15,98 €
	Aireador M-24x100 5l/m. <i>Aerator M24x100, 5 l/min.</i> <i>Aérateur M24x100, 5 l/min.</i>	26106 26107	A-341		6,75 €
	Cobertor M37x1,25. <i>Cover Thread M37x1.25.</i> <i>Cache Filetage M37x1,25.</i>	26106 26107	A-11		2,52 €



























IMPALA

Denominación	Asignado a	Referencia	Uds. Blister	PVP
 Maneta Impala. Impala handle. Manette Impala.	15107 15660 15651/76	AM-307	1 unidad	36,89 €
 Cartucho Ø40 salida conducida. Cartridge Ø40 directed outlet. Cartouche Ø40 sortie dirigée.	15107 15660	AM-35	1 unidad	15,98 €
 Cartucho Ø40 salida libre. Cartridge Ø40 free outlet. Cartouche Ø40 Sortie libre.	15651/76	AM-25	1 unidad	15,98 €
 Aireador M-24x100 (M). Aerator M-24x100 (M). Aérateur M-24x100 (M).	15107 15660 15651/76	A-331	2 unidades	6,75 €
 Caño de tubo. Tube spout. Bec tube.	15651/76	A-956	1 unidad	23,85 €









INOA

Denominación	Asignado a	Acabado	Referencia	Uds. Blister	PVP
 Maneta INOA. INOA Handle. Poignée INOA.	39227 39424 3955 3956/55		AM-373	1 unidad	8,76 €
	39227 39424 3955 3956/55		AM-373/N		9,90 €
	39227 39424 3955 3956/55		AM-373/G		12,78 €
	39227 39424 3955 3956/55		AM-373/RG		12,78 €
	39107 39109		AM-373/AF		8,76 €
	39107/N 39109/N		AM-373/AF/N		9,90 €
	39107/G 39109/G		AM-373/AF/G		12,78 €
	39107/RG 39109/RG		AM-373/AF/RG		12,78 €
	39657 39671		AM-373/IAF		8,76 €
	39671/N		AM-373/IAF/N		9,90 €
	39671/G		AM-373/IAF/G		12,78 €
	39671/RG		AM-373/IAF/RG		12,78 €
 Cartucho Ø35 junta superior. Ø35 Cartridge With Upper Seal. Cartouche Ø35 Joint Supérieure.	39227 39424 39555		AM-53	1 unidad	15,98 €















INOA

	Denominación	Asignado a	Acabado	Referencia	Uds. Blister	PVP
	Cartucho Ø35 junta superior apertura en frío. Ø35 Cartridge With Upper Seal, Cold-Start. Cartouche Ø35 Joint Supérieure, Ouverture à Froid.	39107 39109 39657		AM-63		15,98 €
	Cartucho Ø 35 salida conducida apertura en frío. Ø35 Controlled Outlet Cold-Start Cartridge. Cartouche Ø35 Sortie Conduite, Ouverture à Froid.	39671		AM-65		15,98 €
	Cartucho Ø35 salida conducida. Ø35 Controlled Outlet cartridge. Cartouche Ø35 Sortie Conduite.	39425 39556		AM-29		15,98 €
	Aireador M-22x100. Aerator Thread M22x100. Aérateur Filetage M22x100.	39227		A-308		7,65 €
	Aireador M-24x100 ABS. ABS Aerator Thread M24x100. Aérateur ABS Filetage M24x100.	39555		A-331		6,75 €
	Aireador M-18.5x100 ABS 5l/m. ABS Aerator M18.5x100, 5 l/min. Aérateur ABS M18.5x100, 5 l/min.	39657		A-353		8,37 €
	Aireador M-24x100 ABS 5 l/m. ABS Aerator M24x100, 5 l/min. Aérateur ABS M24x100, 5 l/min.	39107 39109		A-354		7,16 €
	Cobertor M-37x1,25. Cover Thread M37x1.25. Cache Filetage M37x1,25.	39107 39109 39227 39424 39555 39657 39671 39425 39656		A-11		2,52 €
		39107/N 39109/N 39227/N 39424/N 39555/N 39656/N		A-11/N		2,95 €
		39107/G 39109/G 39227/G 39424/G 39555/G 39656/G		A-11/G		3,50 €
		39107/RG 39109/RG 39227/RG 39424/RG 39555/RG 39656/RG		A-11/RG		3,50 €
	Caño de tubo. Spout Tube. Bec Tube.	39657		A-971		27,21 €
	Distribuidor ABS. ABS Diverter. Distributeur ABS.	39555		A-112		12,31 €
	Rótula bidé. Bidet Ball Joint. Rotule Bidet. M-24x100 x M-22x100 (M-M).	39227		A-317		7,19 €









IRIS

	Denominación	Asignado a	Referencia	Uds. Blister	PVP
	Maneta Iris Lavabo. <i>Iris Basin Handle.</i> <i>Poignée Iris Lavabo.</i>	10109 10110	AM-367/1	1 unidad	14,00 €
	Maneta Iris BD. <i>Iris BD Handle.</i> <i>Poignée Iris BD.</i>	10424 10425 10555 /10556	AM-367	1 unidad	14,00 €
	Cartucho Ø 35 junta superior apertura en frío. <i>Ø35 Cartridge With Upper Seal,</i> <i>Cold-Start.</i> <i>Cartouche Ø35 Joint Supérieure,</i> <i>Ouverture à Froid.</i>	10109	AM-63	1 unidad	15,98 €
	Cartucho Ø 35 salida conducido. <i>Ø35 Controlled Outlet cartridge.</i> <i>Cartouche Ø35 Sortie Conduite.</i>	10110 10425 10556	AM-29	1 unidad	15,98 €
	Cartucho Ø 35 junta superior. <i>Ø35 Cartridge With Upper Seal.</i> <i>Cartouche Ø35 Joint Supérieure.</i>	10424 10555	AM-53	1 unidad	15,98 €
	Aireador M-24x100 giroscópico. <i>Swivel Aerator M24x100.</i> <i>Aérateur Orientable M24x100.</i>	10110	A-345	2 unidades	8,14 €
	Aireador M-24x100 giroscópico. <i>Swivel Aerator M24x100.</i> <i>Aérateur Orientable M24x100.</i>	10109 10555	A-344	2 unidades	8,19 €
	Distribuidor. <i>Diverter.</i> <i>Distributeur.</i>	10555	A-139	1 unidad	15,41 €
	Distribuidor empotrada. <i>Built-in Diverter.</i> <i>Distributeur Encastré.</i>	10556	A-141	1 unidad	10,09 €

JET

	Denominación	Asignado a	Referencia	Uds. Blister	PVP
	Maneta JET. JET Handle. Poignée JET.	96107 96227 96555 96424 96651 96658 96660 96670	AM-355	1 unidad	8,76 €
	Cartucho Ø 40 salida libre. Ø40 Free Outlet cartridge. Cartouche Ø40 Sortie libre.	96107 96227 96555 96424	AM-25	1 unidad	15,98 €
	Cartucho Ø 40 salida conducida. Ø40 Controlled Outlet cartridge. Cartouche Ø40 Sortie Conduite.	96658 96660 96651 96670	AM-35	1 unidad	15,98 €
	Tuerca PPE 42x1,25. PPE Nut Thread M42x1.25. Écrou PPE Filetage M42x1,25.	96107 96227 96555 96424 96658 96660 96670	A-109	1 unidad	8,92 €
	Aireador M-24x100 (M). Aerator Thread M24x100 (M). Aérateur Filetage M24x100 (M).	96555 96651 96660 96651	A-331	2 unidades	6,75 €
	Aireador M-24x100 6 l/m. Aerator M24x100, 6 l/min. Aérateur M24x100, 6 l/min.	96107 96109 96657	A-341	2 unidades	6,75 €
	Aireador M-22x100 (H). Aerator Thread M22x100 (F). Aérateur Filetage M22x100 (F).	96227	A-322	2 unidades	8,93 €
	Cobertor M-42x1,25. Cover Thread M42x1.25. Cache Filetage M42x1,25.	96107 96227 96555 96424 96658 96660 96670	A-10	1 unidad	1,86 €
	Rótula bidé. Bidet Ball Joint. Rotule Bidet. M-24x100 x M-22x100 (M-M).	96227	A-306	1 unidad	8,10 €
	Distribuidor. Diverter. Distributeur.	96555	A-112	1 unidad	12,31 €
	Enlace flexo R-1/2" x R-1/2". Hose Connector G1/2" x G1/2". Raccord Flexible G1/2" x G1/2".	96424	A-299	1 unidad	4,94 €
	Flexo extraible. Pull-out Hose. Flexible Extractible.	96670	A-304/80	1 unidad	10,94 €
	Caño Tubo. Spout Tube. Bec Tube.	96657	A-946	1 unidad	31,19 €
	Caño Tubo. Spout Tube. Bec Tube.	96651	A-966	1 unidad	37,47 €







KALI

	Denominación	Asignado a	Referencia	Uds. Blister	PVP
	Volante KALI. <i>KALI handle.</i> <i>Poignée KALI.</i>	13109 13110 13424 13425 13555 13556	AM-370	1 unidad	14,32 €
	Volante KALI baño y ducha. <i>KALI handle.</i> <i>Poignée KALI.</i>	13425 13556 13424 13555	AM-370/1	1 unidad	14,32 €
	Cartucho Ø 35 salida junta superior apertura en frío. <i>Ø 35 cartridge with upper joint outlet and cold start.</i> <i>Cartouche Ø 35 avec sortie par joint supérieur et ouverture à froid.</i>	13109	AM-63	1 unidad	15,98 €
	Cartucho Ø 35 salida conducido. <i>Ø 35 cartridge - directed outlet.</i> <i>Cartouche Ø 35 - sortie dirigée.</i>	13110 13425 13556 13424 13555	AM-29	1 unidad	15,98 €
	Aireador M-24x100 giroscópico oculto. <i>Concealed swivel aerator M-24x100.</i> <i>Aérateur orientable caché M-24x100.</i>	13109	A-344	2 unidades	8,19 €
	Aireador M-24x100 giroscópico oculto. <i>Concealed swivel aerator M-24x100.</i> <i>Aérateur orientable caché M-24x100.</i>	13110	A-345	2 unidades	8,14 €
	Aireador M-24x100 estándar. <i>Standard aerator M-24x100.</i> <i>Aérateur M-24x100 standard.</i>	13555	A-331	2 unidades	6,75 €
	Distribuidor. <i>Diverter.</i> <i>Distributeur.</i>	13555	A-116	1 unidad	16,16 €
	Distribuidor empotrada. <i>Concealed diverter.</i> <i>Distributeur encastré.</i>	13556	A-141	1 unidad	10,09 €





LUCA

	Denominación	Asignado a	Acabado	Referencia	Uds. Blister	PVP
	Maneta Luca. Luca Handle. Poignée Luca.	1410 14109 14227 14555 14424 14657		AM-362	 1 unidad	8,76 €
		14108N 14 09N 14227N 14555N 14424N		AM-362/N		9,90 €
	Cartucho Ø 35 salida junta superior. Ø35 Cartridge With Upper Seal Outlet. Cartouche Ø35 Sortie Joint Supérieure.	14107 14109 14227 14555 14424 14657		AM-52	 1 unidad	15,98 €
	Aireador M-22x100. Aerator Thread M22x100. Aérateur Filetage M22x100.	14227		A-308	 2 unidades	7,65 €
	Aireador M-22x100 5l/m. Aerator M22x100, 5 l/min. Aerator M22x100, 5 l/min.	14657		A-343	 2 unidades	7,65 €
	Aireador M-24x100 5l/m. Aerator M24x100, 5 l/min. Aérateur M24x100, 5 l/min.	14555		A-310	 2 unidades	7,65 €
	Aireador M-24x100 5l/m. Aerator M24x100, 5 l/min. Aérateur M24x100, 5 l/min.	14107 14109		A-341	 2 unidades	6,75 €
	Distribuidor ABS. ABS Diverter. Distributeur ABS.	14555		A-112	 1 unidad	12,31 €
	Cobertor M37x1,25. Cover Thread M37x1.25. Cache Filetage M37x1,25.	14107 14109 14227 / 14555 14424 14657		A-11	 1 unidad	2,52 €
		14107/N 14109/N 14227/N 14555/N 14424/N		A-11/N		2,95 €
	Rótula bidé. Bidet Ball Joint. Rotule Bidet. M-24x100 x M-22x100 (M-M).	14227		A-306	 1 unidad	8,10 €
	Aro base ABS. ABS base ring. Anneau de base en ABS.	14107		A-616	 1 unidad	2,18 €
		14107/N		A-616/N		2,52 €
	Aro base de latón para fregadero. Brass base ring for sink. Anneau de base en laiton pour évier.	14657		A-615	 1 unidad	2,07 €
	Caño de tubo. Spout tube. Bec tube.	14657		A- 970	 1 unidad	27,21 €

MOON

	Denominación	Asignado a	Referencia	Uds. Blister	PVP
	Maneta MOON. MOON Handle. Poignée MOON.	29107 29227 29109	AM-371	1 unidad	11,94 €
	Cartucho Ø 35 salida conducida progresivo 90°. Ø35 Progressive 90° Controlled Outlet cartridge. Cartouche Ø35 Sortie Conduite Progressive 90°.	29107 29227 29109	AM-60	1 unidad	15,98 €
	Aireador M-24x100 giroscópico. Swivel Aerator M24x100. Aérateur Orientable M24x100.	29107 29109	A-345	2 unidades	8,14 €
	Aireador M-16x100 (H). Aerator M16x100 (F). Aérateur M16x100 (F).	29227	A-346	2 unidades	8,19 €
	Rótula bidé. Bidet Ball Joint. Rotule Bidet. M16x100 x M16x100 (M-M).	29227	A-347	1 unidad	7,27 €
	Aro base latón. Brass Base Ring. Anneau de Base Laiton.	29107 29227 29109	A-618	1 unidad	15,08 €















NEOS

	Denominación	Asignado a	Referencia	Uds. Blister	PVP
	Maneta NEOS. NEOS Handle. Poignée NEOS.	94107 94227 94555 94424 94556 94657 94658 94425	AM-354	1 unidad	13,14 €
	Cartucho Ø 35 salida libre. Ø35 Free Outlet cartridge. Cartouche Ø35 Sortie libre.	94657	AM-28	1 unidad	15,98 €
	Cartucho Ø 35 salida junta superior. Ø35 Cartridge With Upper Seal Outlet. Cartouche Ø35 Sortie Joint Supérieure.	94107 94109 94227	AM-47	1 unidad	15,98 €
	Cartucho Ø 35 salida conducida. Ø35 Controlled Outlet cartridge. Cartouche Ø35 Sortie Conduite.	94555 94424 94425 94556	AM-29	1 unidad	15,98 €
	Aireador M-24x100 (M) ABS. ABS Aerator Thread M24x100 (M). Aérateur ABS Filetage M24x100 (M).	94658	A-338	2 unidades	6,62 €
	Aireador M-16x100. Aerator Thread M16x100. Aérateur Filetage M16x100.	94227	A-321	2 unidades	6,75 €
	Aireador M-24x100 (M). Aerator Thread M24x100 (M). Aérateur Filetage M24x100 (M).	94107 - 94109 94555	A-331	2 unidades	6,75 €
	Cobertor M-37x1,25. Cover Thread M37x1.25. Cache Filetage M37x1,25.	94107 94227 94555 94424 94657 94658	A-11	1 unidad	2,52 €
	Caño Tubo rectangular. Rectangular Spout Tube. Bec Tube Rectangulaire.	94657	A-963	1 unidad	42,77 €
	Distribuidor. Diverter. Distributeur.	94555	A-130	1 unidad	12,66 €
	Rótula bidé. Bidet Ball Joint. Rotule Bidet Rotule Bidet. M-16x100 x M-16x100 (M-M).	94227	A-317	1 unidad	7,19 €











ONE

	Denominación	Asignado a	Referencia	Uds. Blister	PVP
	Maneta ONE. ONE Handle. Poignée ONE.	44109 44227 44110 44124 44425 44555 44556	AM-368	1 unidad	13,78 €
		44227/44124 44425 44555 44556	AM-368/1		13,78 €
	Cartucho Ø 35 salida junta superior apertura en frío. Ø35 Cartridge With Upper Seal, Cold-Start. Cartouche Ø35 Joint Supérieure, Ouverture à Froid.	44109	AM-63	1 unidad	15,98 €
	Cartucho Ø 35 salida junta superior. Ø35 Cartridge With Upper Seal. Cartouche Ø35 Joint Supérieure.	44227 44124 44555	AM-53	1 unidad	15,98 €
	Cartucho Ø 35 salida conducido. Ø35 Controlled Outlet cartridge. Cartouche Ø35 Sortie Conduite.	44110 44425 44556	AM-29	1 unidad	15,98 €
	Aireador M-24x100 giroscópico. Swivel Aerator M24x100. Aérateur Orientable M24x100.	44110	A-345	2 unidades	8,14 €
	Aireador M-22x100. Aerator Thread M22x100. Aérateur Filetage M22x100.	44227	A-308	2 unidades	7,65 €
	Aireador M-24x100 giroscópico. Swivel Aerator M24x100. Aérateur Orientable M24x100.	44109 44555	A-344	2 unidades	8,19 €
	Distribuidor. Diverter. Distributeur.	44555	A-139	1 unidad	15,41 €
	Distribuidor. Diverter. Distributeur.	44556	A-141	1 unidad	10,09 €
	Rótula bidé. Bidet Ball Joint. Rotule Bidet Rotule Bidet. M-22x100 x M-22x100 (M-M).	44227	A-334	1 unidad	7,19 €











PISA

	Denominación	Asignado a	Referencia	Uds. Blister	PVP
	Volante Pisa con tornillo inox. <i>Pisa handle with stainless steel screw.</i> <i>Volant Pisa avec vis inox.</i>	Toda la familia pisa	A- 503A		4,38 €
		Toda la familia pisa	A-503R		4,38 €
	Montura estándar cerámica 1/4" v. <i>Standard ceramic headwork ¼ turn.</i> <i>Tête céramique standard ¼ tour.</i>	78101 78620/11 78631/60 78631/58 78624/60 78624/58 78609/60 78602	A- 21		10,12 €
	Aireador M-22x100 (H). <i>Aerator M-22x100 (F).</i> <i>Aérateur M-22x100 (F).</i>	78620/11 78631/60 78631/58 78624/60 78624/58 78609/60	A-308		7,65 €
	Aireador M-20x100 (M). <i>Aerator M-20x100 (M).</i> <i>Aérateur M-20x100 (M).</i>	78101	A-312/B		12,83 €
	Caño de tubo. <i>Tube spout.</i> <i>Bec tube.</i>	78620/11	A-961		23,85 €
	Caño tubo 16 cm. <i>Tube spout 16 cm.</i> <i>Bec tube 16 cm.</i>	78631/58 78624/58	A-960		23,85 €
	Caño tubo 20 cm. <i>Tube spout 20 cm.</i> <i>Bec tube 20 cm.</i>	78631/60 78624/60 78609/60	A-959		28,79 €





























PLAY

	Denominación	Asignado a	Referencia	Uds. Blister	PVP
	Maneta PLAY. PLAY Handle. Poignée PLAY.	98107 98227 98555 98424 98658	AM-356	1 unidad	11,79 €
	Cartucho Ø 40 salida conducida. Ø40 Controlled Outlet cartridge. Cartouche Ø40 Sortie Conduite.	98657	AM-35	1 unidad	15,98 €
	Cartucho Ø 40 salida libre. Ø40 Free Outlet cartridge. Cartouche Ø40 Sortie libre.	98107 98227 98555 98424	AM-25	1 unidad	15,98 €
	Aireador M-22x100 (H) IB. Aerator M22x100 (H) IB. Aérateur M22x100 (H) IB.	98227	A-308	2 unidades	7,65 €
	Aireador M-24x100 IB Homologado. Aerator M24x100 IB Approved. Aérateur M24x100 IB Homologué.	98107 98109 98658	A-341	2 unidades	6,75 €
	Aireador M-24x100 ID Homologado. Aerator M24x100 ID Approved. Aérateur M24x100 ID Homologué.	98555	A-311	2 unidades	10,20 €
	Caño Tubo. Spout Tube. Bec Tube.	98657	A-946	1 unidad	31,19 €
	Cobertor M-42x1,25. Cover Thread M42x1.25. Cache Filetage M42x1,25.	98107 98227 98555 98424 98658	A-10	1 unidad	1,86 €
	Rótula bidé. Bidet Ball Joint. Rotule Bidet. M-24x100 x M-22x100 (M-M) IA.	98227	A-306	1 unidad	8,10 €
	Distribuidor. Diverter. Distributeur.	98555	A-112	1 unidad	12,31 €

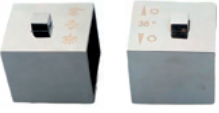

























SEIS

	Denominación	Asignado a	Referencia	Uds. Blister	PVP
	Maneta SEIS. <i>SEIS Handle.</i> <i>Poignée SEIS.</i>	66107 66227 66555 66424 66659/09	AM-345	1 unidad	8,76 €
	Cartucho Ø 40 salida conducida. <i>Ø40 Controlled Outlet cartridge.</i> <i>Cartouche Ø40 Sortie Conduite.</i>	66107 66227 66555 66424	AM-35	1 unidad	15,98 €
	Cartucho Ø 40 salida libre. <i>Ø40 Free Outlet cartridge.</i> <i>Cartouche Ø40 Sortie libre.</i>	66659/09	AM-25	1 unidad	15,98 €
	Aireador M-24x100 (M) Homologado IB. <i>Aerator M24x100 (M) Approved IB.</i> <i>Aérateur M24x100 (M) Homologué IB.</i>	66107 66659/09	A-310	2 unidades	7,65 €
	Aireador M-22x100 (H) Homologado IB. <i>Aerator M22x100 (H) Approved IB.</i> <i>Aérateur M22x100 (H) Homologué IB.</i>	66227	A-308	2 unidades	7,65 €
	Aireador M-28x100 (M) Homologado IB. <i>Aerator M28x100 (M) Approved IB.</i> <i>Aérateur M28x100 (M) Homologué IB.</i>	66555	A-311	2 unidades	10,20 €
	Cobertor M-42x1,25. <i>Cover Thread M42x1.25.</i> <i>Cache Filetage M42x1,25.</i>	66107 66227 66555 66424 66659/09	A-10	1 unidad	1,86 €
	Rótula bidé. Homologada. <i>Bidet Ball Joint.</i> <i>Rotule Bidet.</i> M-24x100 x M-22x100 (M-M)	66227	A-334	1 unidad	7,19 €
	Distribuidor. <i>Diverter.</i> <i>Distributeur.</i>	66555	A-112	1 unidad	12,31 €
	Caño Fundido. <i>Cast Spout.</i> <i>Bec Fonte.</i>	66659/09	A-952	1 unidad	47,72 €







TERMOSTÁTICAS

	Denominación	Asignado a	Acabado	Referencia	Uds. Blister	PVP
	Soporte deslizante. <i>Sliding holder.</i> <i>Support coulissant.</i>	44430 44431 35430 51430 50430 82430 96430		4073	 1 unidad	8,70 €
		44431/N 51430/N 50430/N 82430/3/N		4073/N		9,90 €
		44431/G 82430/3/G		4073/G		11,96 €
		44431/BC 82430/3/BC		4073/BC		11,96 €
		44431/NQ 82430/3/NQ		4073/NQ		11,96 €
		82430/3/RG		4073/RG		11,96 €
	Soporte deslizante barra. <i>Sliding bar holder.</i> <i>Support coulissant de barre.</i>	47430 48430 48530		4116	 1 unidad	8,70 €
	Cartucho distribuidor. <i>Diverter cartridge.</i> <i>Cartouche de distributeur.</i>	44430 44431		A-148	 1 unidad	18,34 €
	Cartucho distribuidor. <i>Diverter cartridge.</i> <i>Cartouche de distributeur.</i>	48430 48530		A-149	 1 unidad	18,34 €
	Cartucho termostática. <i>Thermostatic cartridge.</i> <i>Cartouche thermostatique.</i>	35424 48430 48530 44430 44431 35430		AM-43		63,64 €
	Cartucho termal. <i>Thermal cartridge.</i> <i>Cartouche thermique.</i>	82148 82149		AM-71		63,64 €
	Distribuidor. <i>Diverter.</i> <i>Distributeur.</i>	35555		A-152	 1 unidad	12,31 €
	Distribuidor PUSH. <i>PUSH diverter.</i> <i>Distributeur PUSH.</i>	82148 82149		A-973		18,34 €
	Montura cerámica 1/4". <i>Ceramic headwork.</i> <i>Tête céramique.</i>	35430 35424 35555 44424		A-21	 1 unidad	10,12 €
	Volante distribuidor. <i>Diverter handle.</i> <i>Manette distributeur.</i>	48430 48530		A-525/D	 1 unidad	11,29 €
A-525/D A-525/T		48430 48530		A-525/T		12,78 €
	Volante caudal. <i>Flow handle.</i> <i>Poignée de débit.</i>	35430 35424 35555		A-529/C	 1 unidad	8,79 €
	Volante Temperatura. <i>Temperature handle.</i> <i>Poignée de température.</i>	35430 35424 35555		A-529/T	 1 unidad	10,74 €











TERMOSTÁTICAS

	Denominación	Asignado a	Acabado	Referencia	Uds. Blister	PVP
	Volante distribuidor. <i>Diverter handle.</i> <i>Manette distributeur.</i>	44430		A-530/CD	1 unidad	10,26 €
	Volante Temperatura. <i>Temperature handle.</i> <i>Poignée de température.</i>	44430		A-530/T	1 unidad	10,74 €
	Volante Termal. <i>Thermal handle.</i> <i>Poignée thermique.</i>	44424 44431		A-531/T	1 unidad	9,17 €
		44431/N		A-531/T/N		11,60 €
		44431/G		A-531/T/G		12,20 €
		44431/BC		A-531-T/BC		12,20 €
		44431/NQ		A-531/T/NQ		12,20 €
	Volante caudal. <i>Flow handle.</i> <i>Poignée de débit.</i>	44424 44431		A-531/CD	1 unidad	8,79 €
		44431/N		A-531/CD/N		11,40 €
		44431/G		A-531/CD/G		12,20 €
		44431/BC		A-531/CD/BC		12,20 €
		44431NQ		A-531/CD/NQ		12,20 €
	Volante caudal ABS. <i>Flow handle ABS.</i> <i>Poignée de débit ABS.</i>	51430		A-534/C	1 unidad	8,79 €
		51430/N		A-534/C/N		11,40 €
	Volante Temperatura ABS. <i>Temperature handle ABS.</i> <i>Poignée de température ABS.</i>	51430		A-534/T	1 unidad	9,17 €
		51430/N		A-534/T/N		11,40 €
	Volante Temperatura. <i>Temperature handle.</i> <i>Poignée de température.</i>	82148 82149		A-536/T	1 unidad	10,74 €
		82148/N 82149/N		A-536/T/N		11,60 €
		82148/G 82149/G		A-536/T/G		12,20 €
		82148/BC 82149/BC		A-536/T/BC		12,20 €
		82148/NQ 82149/NQ		A-536/T/NQ		12,20 €



























TERRA

	Denominación	Asignado a	Referencia	Uds. Blister	PVP
	Volante TERRA. TERRA handle. Poignée TERRA.	74107 74227 74555 74424 74657-11	A-509	2 unidades	52,79 €
	Montura cerámica 1/2 vuelta. 1/2 turn ceramic headwork. Tête céramique 1/2 tour.	74107 74227 74555 74424 74657-11	A-20	2 unidades	29,34 €
	Aireador M-24x100 (M). Aerator M-24x100 (M). Aérateur M-24x100 (M).	74555	A-331	2 unidades	6,75 €
	Aireador M-24x100 (H) Ø26. Aerator M-24x100 (F) Ø26. Aérateur M-24x100 (F) Ø26.	74107 74227 74657-11	A-333	2 unidades	11,57 €
	Distribuidor ABS pomo latón. ABS diverter with brass knob. Distributeur en ABS avec bouton en laiton.	74555	A-118	1 unidad	15,80 €
	Rótula bidé. Bidet Ball Joint. Rotule Bidet. M24x100 x M22x100 (M-M).	74227	A-306	1 unidad	8,10 €
	Caño de tubo. Tube spout. Bec en tube.	74657-11	A-962	1 unidad	42,77 €













TRIANON

	Denominación	Asignado a	Referencia	Uds. Blister	PVP
	Maneta Trianon MX. <i>Trianon MX Handle.</i> <i>Poignée Trianon MX.</i>	80107 80227 80555 80424 80658 80652	AM-341	1 unidad	10,35 €
	Cartucho Ø 40 salida libre. <i>Ø40 Free Outlet cartridge.</i> <i>Cartouche Ø40 Sortie libre.</i>	80658	AM-25	1 unidad	15,98 €
	Cartucho Ø 40 salida conducida. <i>Ø40 Controlled Outlet cartridge.</i> <i>Cartouche Ø40 Sortie Conduite.</i>	80107 80227 /80555 80424	AM-35	1 unidad	15,98 €
	Aireador M-24x100 (M) Homologado IB. <i>Aerator M24x100 (M) Approved IB.</i> <i>Aérateur M24x100 (M) Homologué IB.</i>	80107 80658	A-310	2 unidades	7,65 €
	Aireador M-22x100 (H) Homologado IB. <i>Aerator M22x100 (H) Approved IB.</i> <i>Aérateur M22x100 (H) Homologué IB.</i>	80227	A-308	2 unidades	7,65 €
	Aireador M-24x100 (M) Homologado (ID) Baño ducha. <i>Aerator M24x100 (M) Approved (ID) Bath/Shower.</i> <i>Aérateur M24x100 (M) Homologué (ID) Bain/Douche.</i>	80555	A-352	2 unidades	7,65 €
	Distribuidor. <i>Diverter.</i> <i>Distributeur.</i>	80555	A-112	1 unidad	12,31 €
	Cobertor M-42x1,25. <i>Cover Thread M42x1.25.</i> <i>Cache Filetage M42x1,25.</i>	Toda la familia Trianon	A-10	1 unidad	1,86 €
	Mango ducha extraíble. <i>Pull-out Hand Shower.</i> <i>Douchette Extractible.</i>	80670	A-303/40	1 unidad	33,00 €
	Rótula bidé. <i>Bidet Ball Joint.</i> <i>Rotule Bidet.</i> M-24x100 x M-22x100 (M-M).	80227	A-306	1 unidad	8,10 €
	Caño Fundido. <i>Cast Spout.</i> <i>Bec Fonte.</i>	80658 80652	A-940	1 unidad	53,88 €













TUBE

	Denominación	Asignado a	Acabado	Referencia	Uds. Blister	PVP
	Maneta Tube lavabo. Tube Basin Handle. Poignée Tube Lavabo.	40107 40109 40227		AM-366		10,53 €
		40107/N 40109/N 40227/N		AM-366/N		11,80 €
		40107/G 40109/G 40227/G		AM-366/G		13,37 €
		40107/NQ 40109/NQ 40227/NQ		AM-366/NQ		13,37 €
		40107/BC 40109/BC 40227/BC		AM-366/BC		13,63 €
		40107/RG 40109/RG 40227/RG		AM-366/RG		13,63 €
	Maneta Tube ø35. Tube Ø35 Handle. Poignée Tube Ø35.	40555 40424 40110 40425 40556		AM-366/1		10,53 €
		40555 40424 40110 40425 40556		AM-366/1/N		11,80 €
		40555 40424 40110 40425 40556		AM-366/1/G		13,37 €
		40555 40424 40110 40425 40556		AM-366/1/NQ		13,37 €
		40555 40424 40110 40425 40556		AM-366/1/BC		13,63 €
		40555 40424 40110 40425 40556		AM-366/1/RG		13,63 €
	Maneta fregadera. Sink handle. Poignée d'évier.	82693		AM-348/2		14,26 €
	Cartucho Ø 35 salida conducida apertura en frío. Ø35 Controlled Outlet Cold-Start Cartridge. Cartouche Ø35 Sortie Conduite, Ouverture à Froid.	40112		AM-65		15,98 €
	Cartucho Ø 27 salida junta superior apertura en frío. Ø27 Cartridge With Upper Seal, Cold-Start. Cartouche Ø27 Joint Supérieure, Ouverture à Froid.	40107 40109 40227		AM-64		15,98 €
	Cartucho Ø 35 salida conducido. Ø35 Controlled Outlet cartridge. Cartouche Ø35 Sortie Conduite.	40555 40425 40556 40424 40110		AM-29		15,98 €
	Aireador M-24x100 oculto giroscópico 5l/m. Concealed Swivel Aerator M24x100, 5 l/min. Aérateur Caché Orientable M24x100, 5 l/min.	40110		A-345		8,14 €

TUBE

	Denominación	Asignado a	Acabado	Referencia	Uds. Blister	PVP
	Aireador M-16x100. <i>Aerator Thread M16x100.</i> <i>Aérateur Filetage M16x100.</i>	40227		A-350	2 unidades	8,36 €
	Aireador M-24x100 estándar. <i>Standard Aerator M24x100.</i> <i>Aérateur Standard M24x100.</i>	40555		A-331	2 unidades	6,75 €
	Aireador M-16x100 giroscópico 5 l/m. <i>Swivel Aerator M16x100, 5 l/min.</i> <i>Aérateur Orientable M16x100, 5 l/min.</i>	40107 40109		A-348	2 unidades	8,36 €
	Aro base latón cromo. <i>Brass base ring chrome.</i> <i>Anneau de base en laiton chromé.</i>	40107 40109 40227		A-620	1 unidad	8,21 €
		40107N 40109N 40227N		A-620/N		9,20 €
		40107G 40109G 40227G		A-620/G		10,42 €
		40107NQ 40109NQ 40227NQ		A-620/NQ		10,42 €
		40107BC 40109BC 40227BC		A-620/BC		10,95 €
		40107RG 40109RG 40227RG		A-620/RG		10,95 €
	Distribuidor. <i>Diverter.</i> <i>Distributeur.</i>	40555		A-116	1 unidad	16,16 €
	Distribuidor empotrada. <i>Built-in Diverter.</i> <i>Distributeur Encastré.</i>	40556		A-141	1 unidad	10,09 €
	Rótula bidé. <i>Bidet Ball Joint.</i> <i>Rotule Bidet.</i> M-16x1 x M-16x1 (M-M).	40227		A-349	1 unidad	7,27 €

VERONA

	Denominación	Asignado a	Referencia	Uds. Blister	PVP
	Volante Verona con tornillo inox. <i>Verona handle with stainless steel screw.</i> <i>Volant Verona avec vis inox.</i>	Toda la familia verona	A-510	2 unidades	10,03 €
	Tapa índice color azul. <i>Blue index cap.</i> <i>Capuchon indicateur bleu.</i>	73107 73227 73555 73424 73101 73201 73702 73657/11 73631/60 73631/58 73624/60 73624/58 73609/60 73602 73004 73614 73617 73620/11	A-186	2 unidades	4,00 €
	Tapa índice color rojo. <i>Red index cap.</i> <i>Capuchon indicateur rouge.</i>	73107 73227 73555 73424 73101 73201 73702 73657/11 73631/60 73631/58 73624/60 73624/58	A-187	2 unidades	4,00 €
	Montura espiga larga. <i>Long-tail headwork.</i> <i>Tête tige longue.</i>	73702	A-32	1 unidad	10,20 €
	Montura estándar soleta. <i>Standard headwork with gasket.</i> <i>Tête standard avec joint.</i>	73107 73227 73555 73424 73101 73201 73657/11 73631/60 73631/58 73624/60 73624/58 73609/60 73602 73004 73614 73617 73620/11	A-30	1 unidad	7,90 €
	Aireador M-22x100 (H). <i>Aerator M-22x100 (F).</i> <i>Aérateur M-22x100 (F).</i>	73227 73657/11 73631/60 73631/58 73624/60 73624/58 73609/60 73620/11	A-308	2 unidades	7,65 €
	Aireador M-24x100 (H). <i>Aerator M-24x100 (F).</i> <i>Aérateur M-24x100 (F).</i>	73107 73555	A-331	2 unidades	6,75 €
	Rotula bidé M-24 x M-22. <i>Bidet swivel joint M-24 x M-22.</i> <i>Raccord orientable bidet M-24 x M-22.</i>	73227	A-306	2 unidades	8,10 €
	Distribuidor. <i>Diverter.</i> <i>Distributeur.</i>	73555	A-113	1 unidad	10,65 €
	Caño de tubo. <i>Tube spout.</i> <i>Bec tube.</i>	73620/11	A-961	1 unidad	23,85 €
	Caño de tubo. <i>Tube spout.</i> <i>Bec tube.</i>	73657/11	A-957	1 unidad	23,85 €
	Caño de tubo 21 cm. <i>Tube spout 21 cm.</i> <i>Bec tube 21 cm.</i>	73631/58 73624/58 73609/60	A-960	1 unidad	23,85 €
	Caño de tubo 25 cm. <i>Tube spout 25 cm.</i> <i>Bec tube 25 cm.</i>	73631/60 73624/60	A-959	1 unidad	28,79 €

Gama SHOWROOM



Impulsa la visibilidad de los productos Boet en tu punto de venta. Nuestros expositores están diseñados para presentar la grifería de forma clara, atractiva y coherente con la marca.

Soluciones de marketing pensadas para facilitar la venta y reforzar la identidad Boet. Una experiencia de compra más clara, eficaz y satisfactoria para tus clientes.

Boost the visibility of Boet products at your point of sale. Our displays are designed to present tapware in a clear, attractive way, fully aligned with the brand. Marketing solutions created to support sales and strengthen the Boet identity. A clearer, more efficient and more satisfying purchasing experience for your customers.

Renforcez la visibilité des produits Boet sur votre point de vente. Nos présentoirs sont conçus pour mettre en valeur la robinetterie de manière claire, attractive et cohérente avec la marque.

Des solutions marketing pensées pour faciliter la vente et renforcer l'identité Boet. Une expérience d'achat plus claire, plus efficace et plus satisfaisante pour vos clients.



EXPOSITORES DE PIE

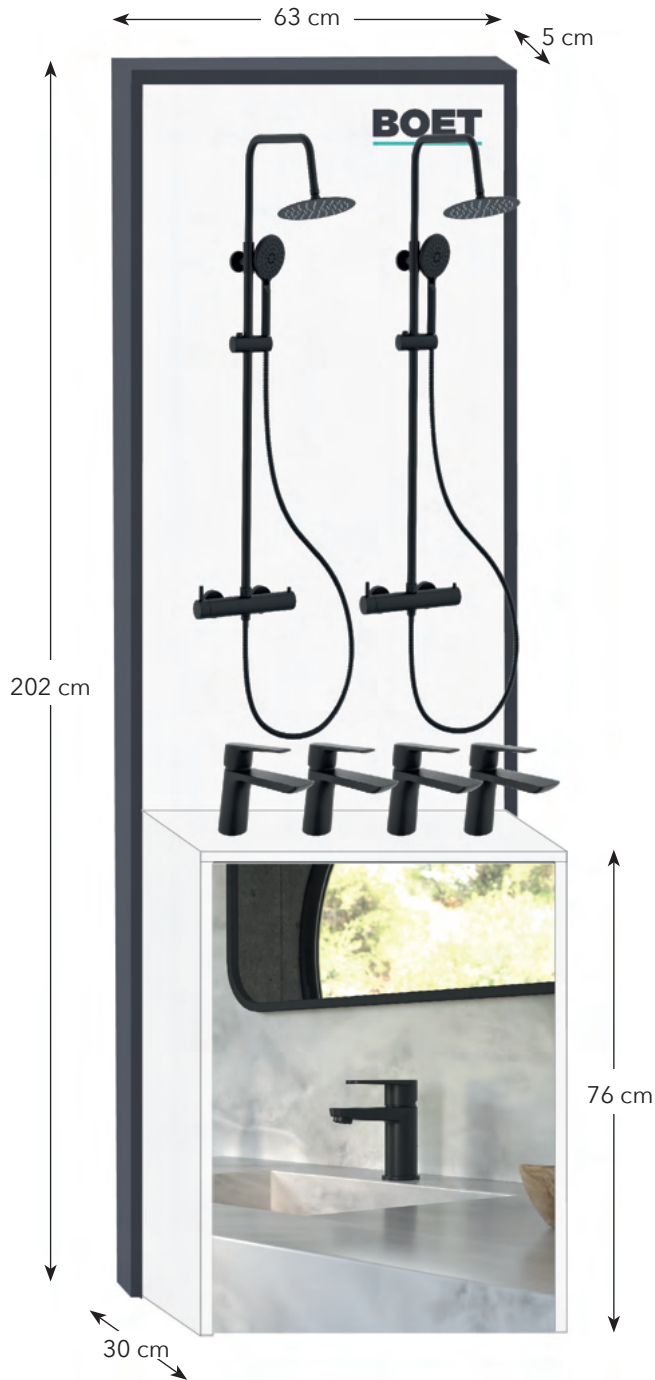

EXPOSITOR 001

Expositor panel en madera lacada en blanco a pared para 4 grifos y 2 duchas.

Wall-mounted white lacquered wood panel display for 4 taps and 2 showers.

Présentoir mural en bois laqué blanc pour 4 robinets et 2 douches.

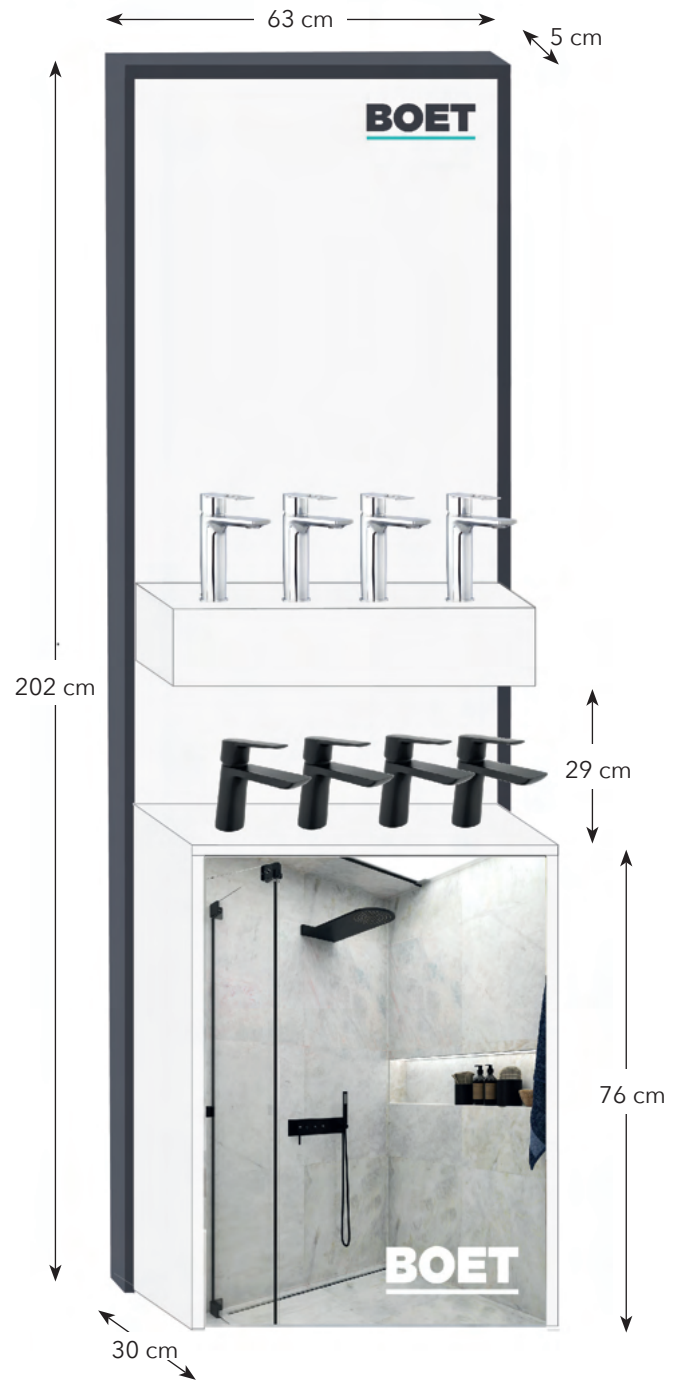

EXPOSITOR 002

Expositor panel en madera lacada en blanco a pared para 8 grifos.

Wall-mounted white lacquered wood panel display for 8 taps.

Présentoir mural en bois laqué blanc pour 8 robinets.

EXPOSITORES DE PIE

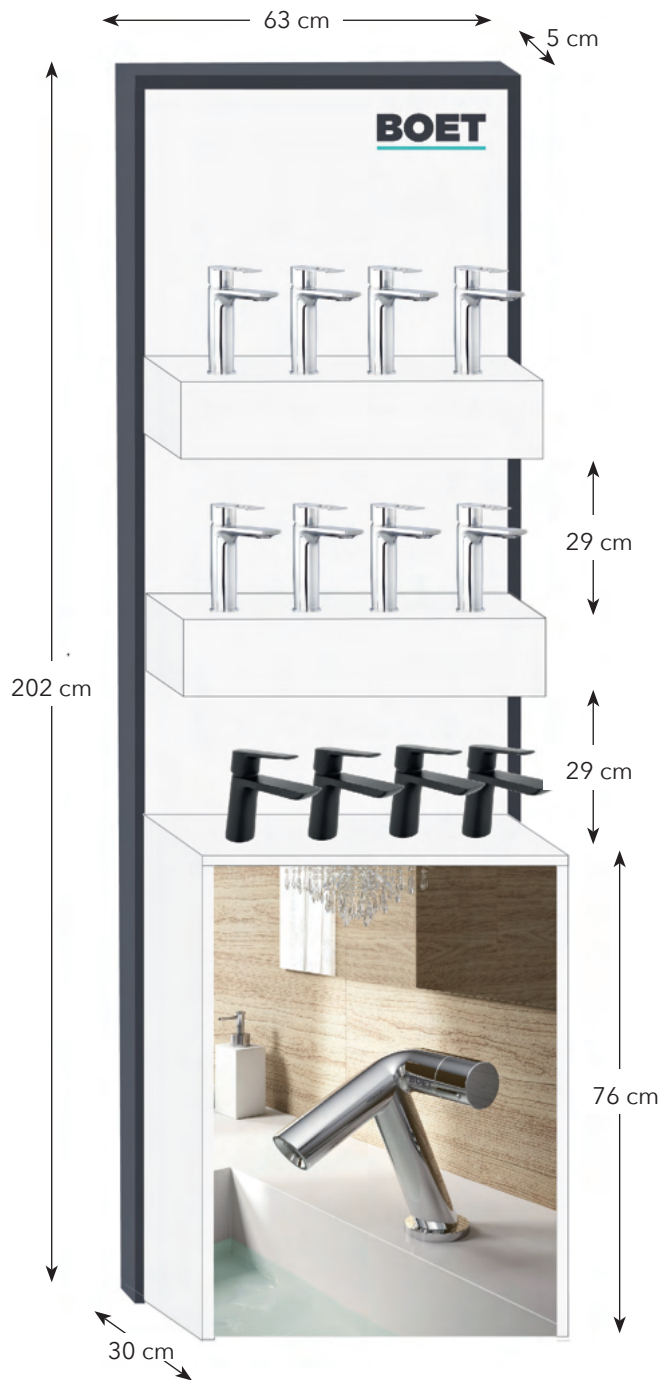

EXPOSITOR 003

Expositor panel en madera lacada en blanco a pared para 12 grifos.

Wall-mounted white lacquered wood panel display for 12 taps.

Présentoir mural en bois laqué blanc pour 12 robinets.

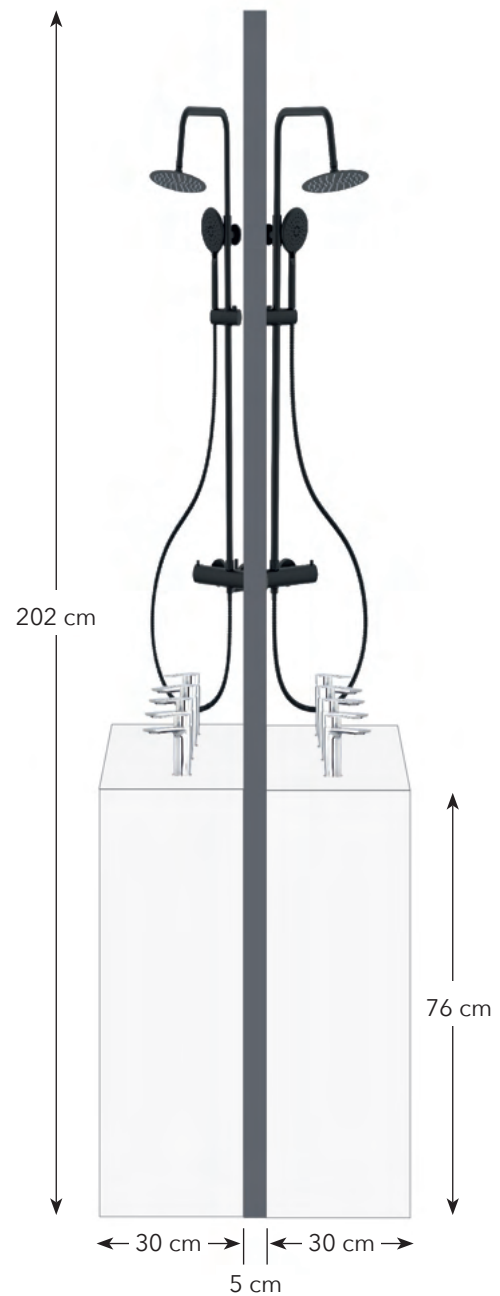

EXPOSITOR 004

Expositor isla en madera lacada en blanco, a dos lados, para 8 grifos y 4 duchas.

Floor display in white lacquered wood, on two sides, for 8 taps and 4 showers.

Présentoir de sol en bois laqué blanc, sur deux faces, pour 8 robinets et 4 douches.

EXPOSITORES DE PIE

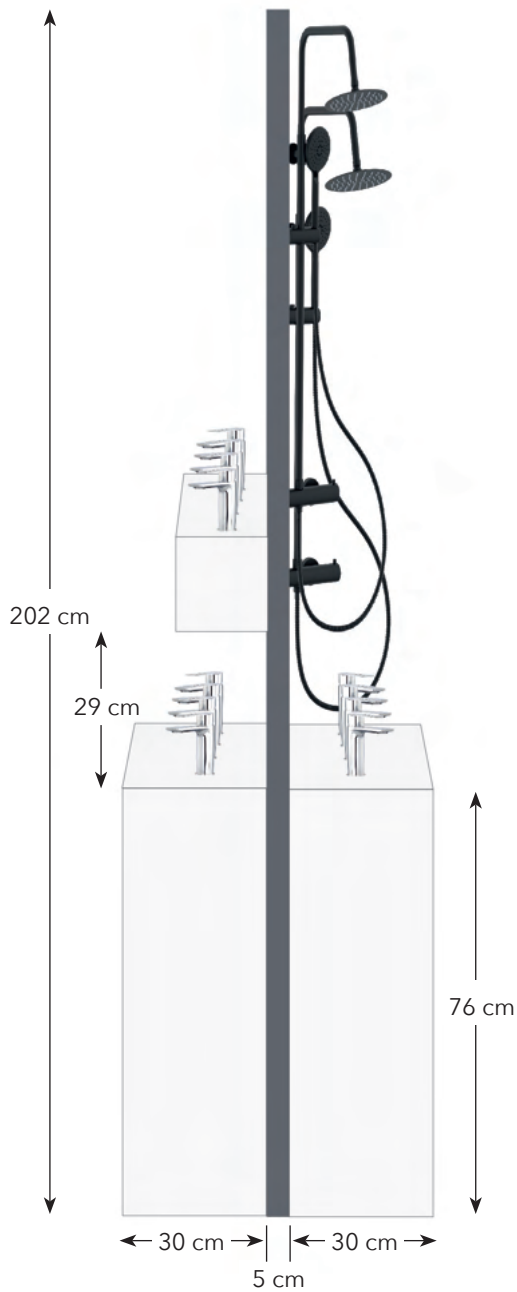

EXPOSITOR 005

Expositor isla en madera lacada en blanco, a dos lados, para 12 grifos y 2 duchas.

Floor display in white lacquered wood, on two sides, for 12 taps and 2 showers.

Présentoir de sol en bois laqué blanc, sur deux faces, pour 12 robinets et 2 douches.

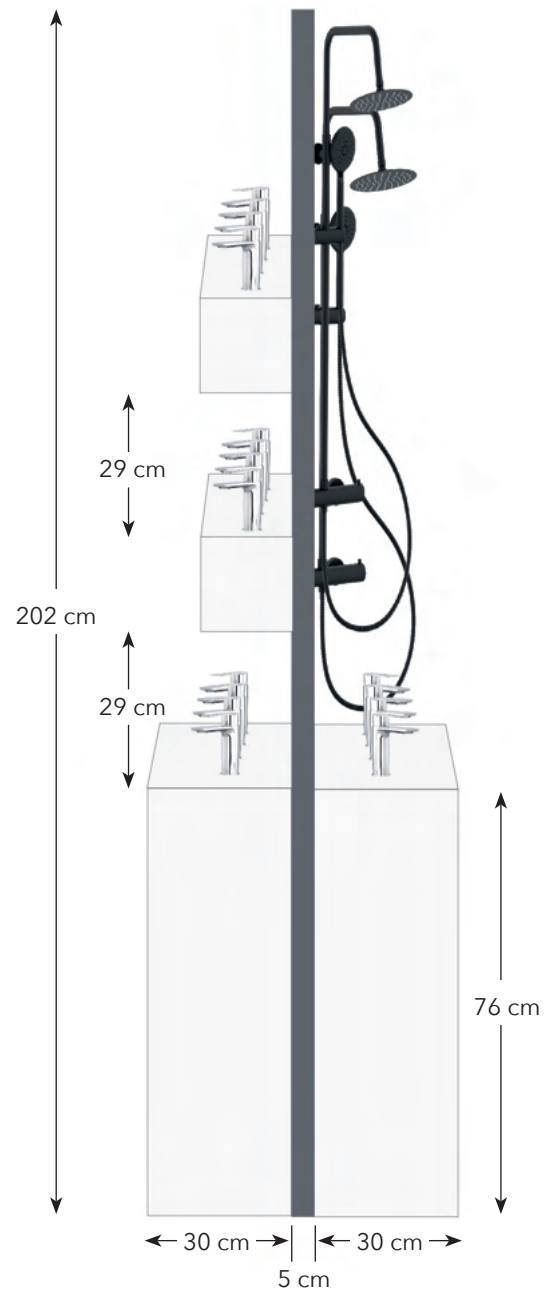

EXPOSITOR 006

Expositor isla en madera lacada en blanco, a dos lados, para 16 grifos y 2 duchas.

Floor display in white lacquered wood, on two sides, for 16 taps and 2 showers.

Présentoir de sol en bois laqué blanc, sur deux faces, pour 16 robinets et 2 douches.

EXPOSITORES DE PIE

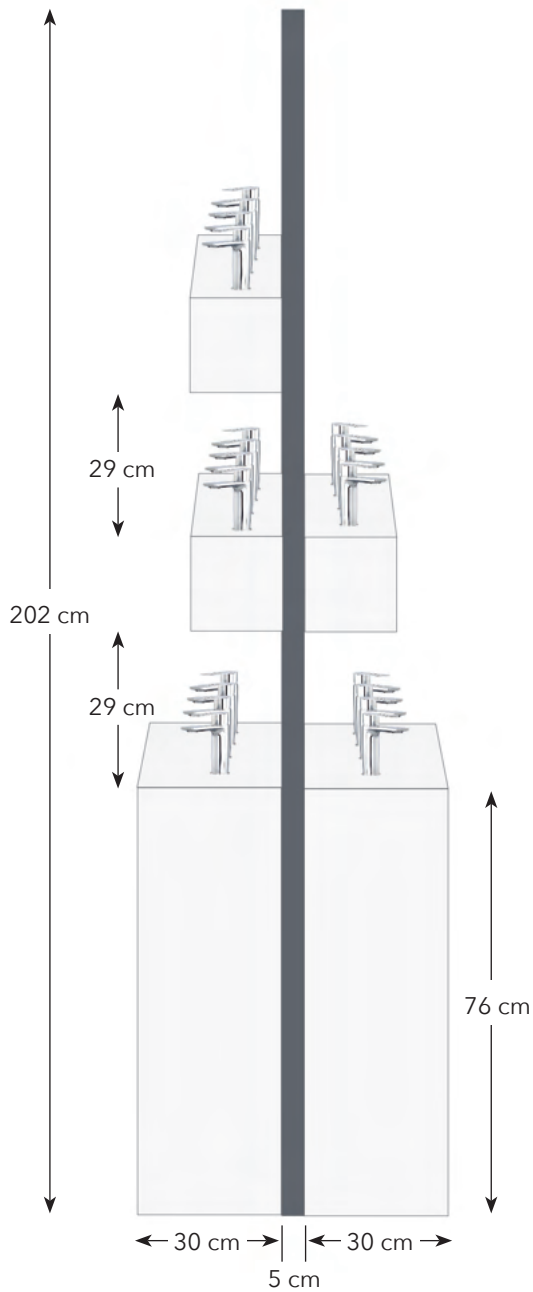

EXPOSITOR 007

Expositor isla en madera lacada en blanco, a dos lados para 20 grifos.

Floor display in white lacquered wood, on two sides, for 20 taps.

Présentoir de sol en bois laqué blanc, sur deux faces, pour 20 robinets.

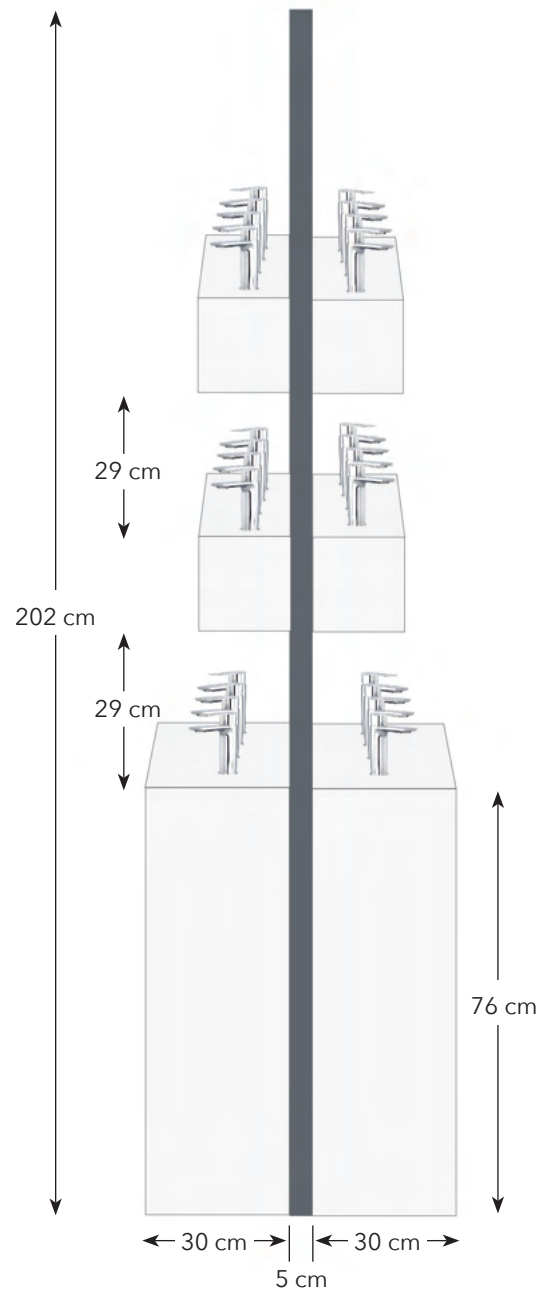

EXPOSITOR 007

Expositor isla en madera lacada en blanco, a dos lados, para 24 grifos.

Floor display in white lacquered wood, on two sides, for 24 taps.

Présentoir de sol en bois laqué blanc, sur deux faces, pour 24 robinets.

EXPOSITORES DE PIE

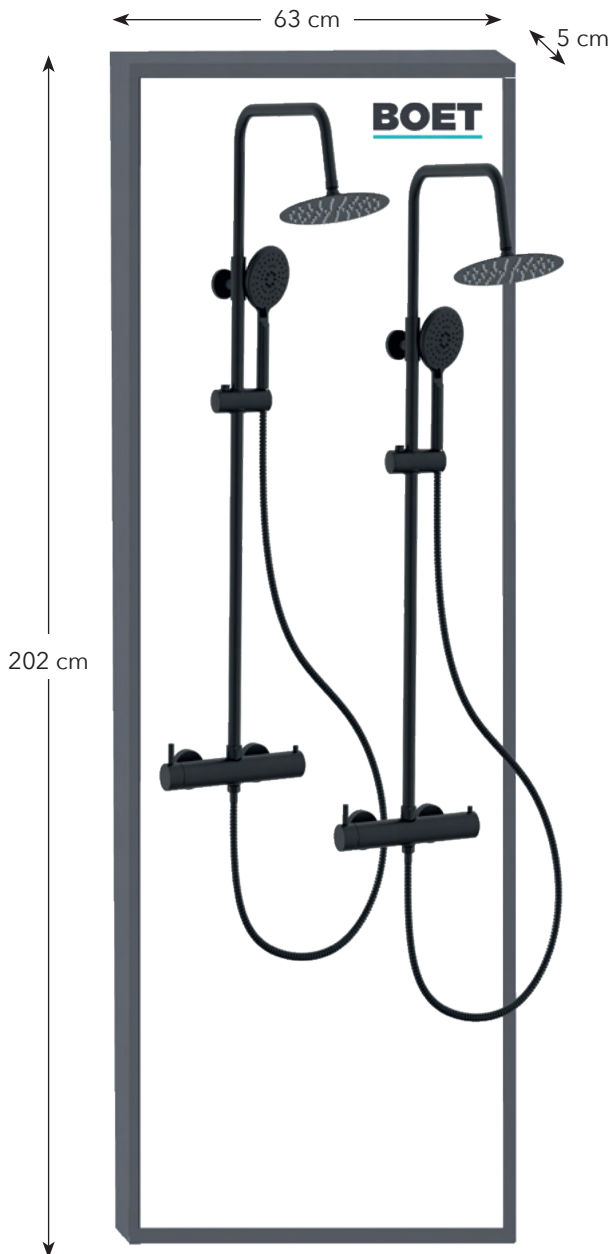

EXPOSITOR 023

Panel expositor de pared en madera lacada en blanco para 2 barras de ducha vistas.

Wall-mounted white lacquered wood panel display for 2 shower bars.

Présentoir mural en bois laqué blanc pour 2 barres de douche.

EXPOSITORES DE SOBREMESA



EXPOSITOR PEANA 0015 EXPOSITOR PEANA 0024

Peana expositora metálica para exponer grifos sobre lavabos o estantes.

Metal display stand to display faucets on sinks or shelves.

Présentoir en métal pour exposer des robinets sur éviers ou étagères.



EXPOSITOR SOBREMESA

Expositor de sobremesa en madera lacada en blanco para 3 grifos.

White lacquered wood tabletop display for 3 taps.

Présentoir de table en bois laqué blanc, pour 3 robinets.



◀ HOTEL
BARCELÓ RAVAL
Barcelona

HOTEL ▶
AXEL
Barcelona

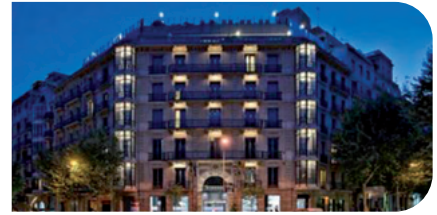

◀ HOTEL TIARA
MIRAMAR BEACH
France

HOTEL ▶
ACTA MADFOR
Madrid

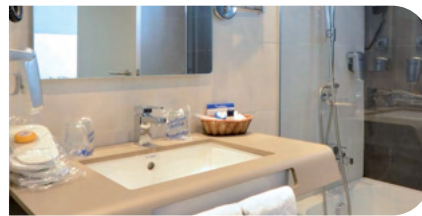

◀ HOTEL
BENALMADENA
PLAYA
Málaga

HOTEL ▶
BRONZE PLAYA
Las Palmas



◀ GRAN HOTEL
BAHÍA DUQUE
Tenerife

LUXURY APART. ▶
MARRAQUECH
Morocco

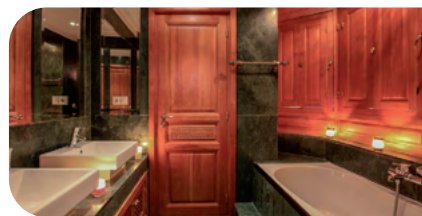



◀ HOTEL
LE NEGRESKO
Francia

HOTEL MELIÁ ▶
COHIBA
Cuba



◀ HOTEL
COPACABANA
Cuba

HOTEL MELIÁ ▶
LAS ANTILLAS
Cuba



◀ CN
SANT ANDREU
Barcelona

HOSPITAL VIRGEN ▶
DE LA MACARENA
Sevilla

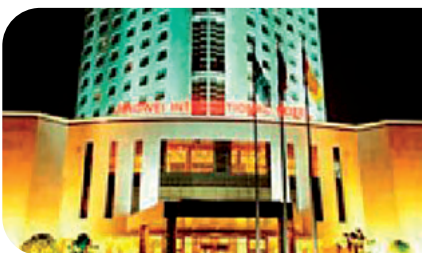

▶ HOTEL
JINGWEI
China

▶ HOTEL
YANGZHOU
China

▶ TEATRE NACIONAL
CATALUNYA
Barcelona

CONDICIONES COMERCIALES

Preámbulo:

Las presentes Condiciones Comerciales regulan de forma general las relaciones de compraventa entre Feliu Boet, S.A., en calidad de fabricante y proveedor de grifería, y los clientes que adquieren sus productos. Estas disposiciones constituyen el marco jurídico que rige todos los pedidos, entregas y operaciones comerciales realizadas con la empresa, prevaleciendo sobre cualesquiera otras condiciones que no hayan sido expresamente aceptadas por escrito por Feliu Boet. La realización de un pedido implica la aceptación íntegra y sin reservas de las presentes Condiciones Comerciales, que se consideran incorporadas a todos los contratos de compraventa celebrados con Feliu Boet.

1. Precios

Los precios indicados en esta tarifa incluyen el embalaje estándar y se entienden para mercancía situada en nuestros almacenes. En península y Baleares (España) los pedidos con un importe superior a 360 € netos se servirán a portes pagados. Los precios no incluyen el IVA ni otros impuestos aplicables. Para cualquier otro destino, se valorará en cada caso.

2. Envíos

Todos los productos se envían por cuenta y riesgo del destinatario, incluso cuando se realicen a portes pagados. Feliu Boet no asumirá responsabilidad alguna por averías, daños, pérdidas o retrasos ocasionados durante el transporte. Cualquier reclamación relacionada con estos incidentes deberá dirigirse directamente a la empresa transportista.

3. Plazos de entrega

Los pedidos se servirán en el menor plazo posible, de acuerdo con nuestra capacidad de fabricación y disponibilidad, y podrán realizarse en entregas parciales. Debido a ello, los retrasos en la entrega no darán derecho a indemnización ni a reclamación alguna.

4. Devoluciones

No se aceptarán devoluciones sin la autorización previa de nuestro Departamento Comercial. No se admitirán devoluciones de productos no incluidos en la tarifa vigente. Los materiales con daños producidos fuera de nuestras instalaciones no podrán devolverse. En caso de que el embalaje presente deterioro al devolver un producto, se aplicará una depreciación del 20 % sobre el precio neto a abonar.

5. Condiciones de pago

Las facturas deberán abonarse al contado o en un plazo máximo de 60 días desde la fecha de emisión, en función de lo que conste en la factura. El primer pedido a nuevos clientes deberá realizarse contra reembolso o al contado en el momento de la descarga del material. Cualquier retraso en el pago con respecto a las fechas pactadas conllevará la suspensión inmediata de futuros envíos. Los abonos se aplicarán conforme al precio de la tarifa vigente en la fecha de compra.

6. Garantía

Nuestra garantía cubre exclusivamente la sustitución de piezas que sean reconocidas como defectuosas por nuestro Departamento de Control de Calidad. Quedan excluidos de la garantía aquellos daños producidos por un uso inadecuado o por un mantenimiento o limpieza indebidos. La garantía cubre la reparación del material sin cargo o bien la sustitución o reparación de las piezas defectuosas verificadas por nuestro departamento de calidad. Feliu Boet no asumirá indemnización alguna ni costes de instalación de los productos defectuosos. Para su aplicación será imprescindible presentar el certificado de garantía que acompaña a cada grifería.

7. Modificaciones de precios

Los precios indicados en nuestros catálogos y en nuestra página web tienen carácter meramente informativo. Feliu Boet se reserva el derecho de modificar precios, características o condiciones sin previo aviso.

8. Reserva de propiedad

Los productos entregados al cliente serán propiedad de Feliu Boet hasta que se haya realizado el pago completo de la factura correspondiente.

9. Validez

Esta tarifa de precios de venta anula las anteriores y estarán vigentes hasta que Feliu Boet comunique cualquier cambio.

10. Jurisdicción

Cualquier disputa, controversia o reclamación que surja de o en relación con un pedido, será resuelta mediante la aplicación de la ley en España y se someterá a la jurisdicción exclusiva de los juzgados y tribunales de Barcelona (España).

TERMS AND CONDITIONS OF SALE

Preamble

These Terms and Conditions of Sale generally govern the sales relationships between Feliu Boet, S.A., in its capacity as manufacturer and supplier of taps, and the customers who purchase its products. These provisions constitute the legal framework governing all orders, deliveries and commercial transactions carried out with the company, prevailing over any other conditions not expressly accepted in writing by Feliu Boet.

The placing of an order implies full and unconditional acceptance of these Terms and Conditions of Sale, which shall be deemed incorporated into all contracts of sale concluded with Feliu Boet.

1. Prices

The prices indicated in this price list include standard packaging and are understood to be ex-works (from our warehouses). In mainland Spain and the Balearic Islands, orders exceeding €360 net will be delivered carriage paid. Prices do not include VAT or other applicable taxes. For any other destination, conditions will be assessed on a case-by-case basis.

2. Shipping

All products are shipped at the consignee's risk, even when dispatched carriage paid. Feliu Boet shall not assume any liability for breakages, damages, losses or delays occurring during transport. Any claims relating to such incidents must be made directly to the carrier.

3. Delivery periods

Orders will be fulfilled as quickly as possible, in accordance with our production capacity and availability, and may be delivered in partial shipments. Delivery delays shall not give rise to any right to compensation or claims.

4. Returns

No returns will be accepted without prior authorisation from our Sales Department. Returns of products not included in the current price list will not be accepted. Materials damaged outside our facilities cannot be returned. In the event of damaged packaging upon return, a depreciation of 20% will be applied to the net price to be refunded.

5. Payment terms

Invoices must be paid in cash or within a maximum period of 60 days from the invoice date, as specified on the invoice. The first order placed by new customers must be paid cash on delivery or upon unloading of the goods. Any delay in payment in relation to the agreed due dates will result in the immediate suspension of future deliveries. Credit notes will be applied according to the price list in force on the date of purchase.

6. Warranty

Our warranty exclusively covers the replacement of parts recognised as defective by our Quality Control Department. Damages resulting from improper use, maintenance or cleaning are excluded. The warranty covers free repair of the goods or the replacement/repair of defective parts verified by our Quality Department. Feliu Boet shall not assume any liability for compensation or installation costs of defective products. To apply the warranty, the warranty certificate supplied with each tap must be presented.

7. Price modifications

The prices indicated in our catalogues and on our website are for information purposes only. Feliu Boet reserves the right to modify prices, features or conditions without prior notice.

8. Retention of title

Products delivered to the customer shall remain the property of Feliu Boet until full payment of the corresponding invoice has been made.

9. Validity

This sales price list cancels all previous ones and shall remain valid until Feliu Boet communicates any changes.

10. Jurisdiction

Any dispute, controversy or claim arising from or in connection with an order shall be governed by Spanish law and shall be subject to the exclusive jurisdiction of the courts of Barcelona (Spain).

CONDITIONS GÉNÉRALES DE VENTE

Préambule

Les présentes Conditions Générales de Vente régissent de manière générale les relations de vente entre Feliu Boet, S.A., en qualité de fabricant et fournisseur de robinetterie, et les clients qui acquièrent ses produits. Ces dispositions constituent le cadre juridique applicable à toute commande, livraison et opération commerciale effectuée avec la société, et prévalent sur toute autre condition qui n'aurait pas été expressément acceptée par écrit par Feliu Boet. La passation d'une commande implique l'acceptation pleine et sans réserve des présentes Conditions Générales de Vente, lesquelles sont réputées intégrées à tout contrat de vente conclu avec Feliu Boet.

1. Prix

Les prix indiqués dans le présent tarif incluent l'emballage standard et s'entendent départ entrepôt (ex works). En Espagne continentale et aux îles Baléares, les commandes supérieures à 360 € nets seront livrées franco de port. Les prix n'incluent pas la TVA ni d'autres taxes applicables. Pour toute autre destination, les conditions seront déterminées au cas par cas.

2. Expéditions

Tous les produits sont expédiés aux risques et périls du destinataire, même en cas d'expédition franco de port. Feliu Boet n'assurera aucune responsabilité pour les avaries, dommages, pertes ou retards survenus pendant le transport. Toute réclamation relative à ces incidents devra être adressée directement au transporteur.

3. Délais de livraison

Les commandes seront exécutées dans les meilleurs délais, en fonction de notre capacité de production et de la disponibilité, et pourront faire l'objet de livraisons partielles. Les retards de livraison ne donneront droit à aucune indemnisation ni à aucune réclamation.

4. Retours

Aucun retour ne sera accepté sans l'autorisation préalable de notre Département Commercial. Les retours de produits non inclus dans le tarif en vigueur ne seront pas acceptés. Les matériels endommagés en dehors de nos installations ne pourront pas être repris. En cas d'emballage détérioré lors d'un retour, une dépréciation de 20 % sera appliquée sur le prix net à rembourser.

5. Conditions de paiement

Les factures devront être réglées au comptant ou dans un délai maximum de 60 jours à compter de leur date d'émission, conformément aux indications portées sur la facture. La première commande d'un nouveau client devra être effectuée contre remboursement ou au comptant lors du déchargement de la marchandise. Tout retard de paiement par rapport aux échéances convenues entraînera la suspension immédiate des livraisons futures. Les avois seront appliqués conformément au tarif en vigueur à la date d'achat.

6. Garantie

Notre garantie couvre exclusivement le remplacement des pièces reconnues comme défectueuses par notre Département de Contrôle Qualité. Sont exclus de la garantie les dommages résultant d'une utilisation inappropriée ou d'un entretien ou nettoyage incorrect. La garantie couvre la réparation gratuite du matériel ou bien le remplacement/réparation des pièces défectueuses vérifiées par notre Département Qualité. Feliu Boet n'assurera aucune indemnisation ni aucun frais d'installation liés aux produits défectueux. Pour son application, la présentation du certificat de garantie accompagnant chaque robinet est obligatoire.

7. Modifications de prix

Les prix indiqués dans nos catalogues et sur notre site internet sont donnés à titre purement indicatif. Feliu Boet se réserve le droit de modifier les prix, caractéristiques ou conditions sans préavis.

8. Réserve de propriété

Les produits livrés au client demeurent la propriété de Feliu Boet jusqu'au paiement intégral de la facture correspondante.

9. Validité

Le présent tarif de vente annule et remplace les précédents et restera en vigueur jusqu'à ce que Feliu Boet communique tout changement.

10. Jurisdiction compétente

Tout litige, controverse ou réclamation relatif à une commande sera régi par le droit espagnol et soumis à la compétence exclusive des tribunaux de Barcelone (Espagne).



BOET

Contacta con nosotros:
Contact us:
Contactez-nous:

BOET

📍 Calle Newton, 18-20
08635, Sant Esteve Sesrovires
Barcelona - Spain

☎ +34 684 05 04

🌐 www.feliuboet.com



Contacto comercial:
Comercial contact:
Contact commercial:

📧 comercial@feliuboet.com

Departamento de administración:
Administration:
Département de l'administration:

📧 admon@feliuboet.com

Servicio de atención
técnica al cliente:
Technical suport:
Service client:

📧 calidad@feliuboet.com

Síguenos:



BOET

BOET

Calle Newton, 18 - 20
08635 Sant Esteve Sesrovires
Barcelona - Spain

0034 93 684 05 04
feliuboet@feliuboet.com
www.feliuboet.com

